

ORBIT[®] architectural
lighting solutions



A blurred high-speed train in motion, moving from left to right across the frame. The train is white with blue accents. In the background, a city skyline is visible under a sunset sky with orange and yellow hues. The overall image has a sense of speed and forward momentum.

**you're
on the
right
track**



→ 48V System	6
→ Luminaires	20
→ Lineairs	46
→ Tracks	56
→ Slim Range	68
→ Accessories	90
→ General info	94

This way →

We believe in an energy efficient future, with lines and curves in all shapes & sizes where the only limit is your imagination.

We believe in highlighting the important things, no matter where life brings us. We believe in beautiful experiences in a fascinating universe. We believe that future starts now!

Low voltage lighting centralizes power supply.

Discover all advantages of the ORBIT 48V TRACK SYSTEM:
above all we guarantee full safety of the low voltage system.
In its compactness, the system is easy to install, resulting in
an efficient installation, which can save valuable time.

Safe



Compact

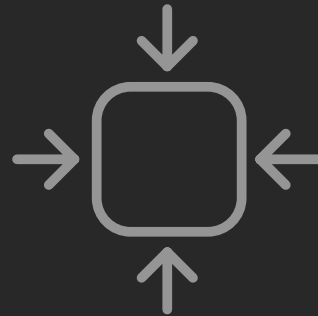

Easy to install

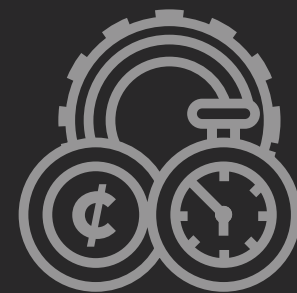

Efficient

CHECK, CHECK, DOUBLE CHECK.

slender
tracks
slim
luminaires
smart
controls
saving
energy



The ORBIT 48V TRACK SYSTEM combines unornamented aesthetics with a multitude of configuration options and effortless installation. The outcome is an ecosystem of quality components perfect for spaces where constant flexibility and high performance are required.



Unornamented
aesthetics with
a multitude
of options
and effortless
installation

48V
track
system

the original

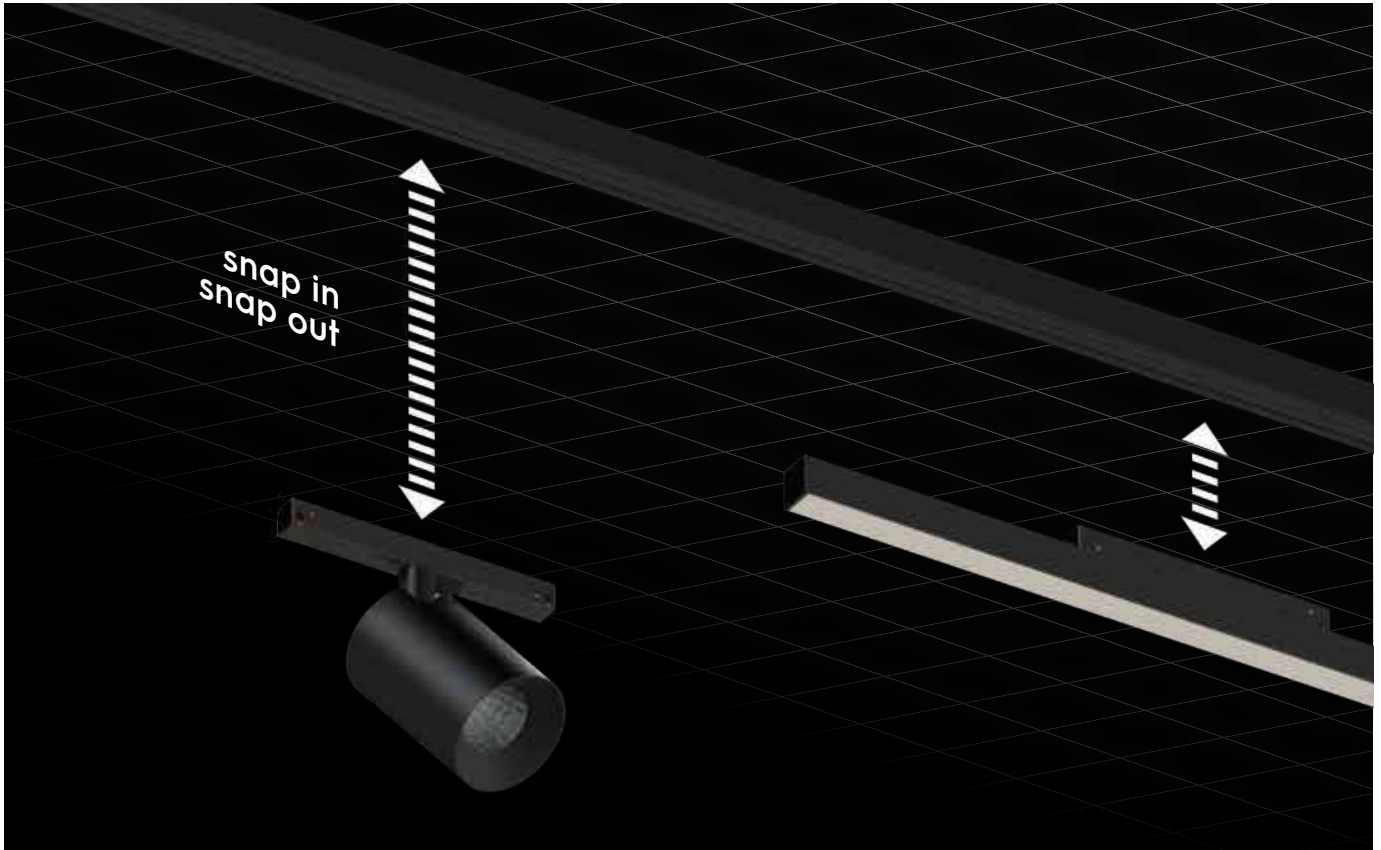

smooth snap mounting

All luminaires have a smooth snap adapter. This eliminates the need for installation tools, giving you the freedom to adjust the position and rotation at any time. It only takes a matter of seconds and one simple hand movement to remove a luminaire.



Choose from
a wide range of color
temperatures,
CRI values and
dimming options.

light
colors

wireless controls

Seamless
and instant
control and
dimming
with the
remote app
for iOS and
Android.



Create a more intimate setting with our **DIM-TO-WARM** technology. Dim the light for a softer glow and a warmer light color. Tadaa, instant coziness! **DIM-TO-WARM** is available for all 48V spotlights.

NEW Improved color mixing for narrow beams

set the mood



dim-to-warm
technology



new sparkly color

Now available
with a champagne
finish for a timeless,
classic look.

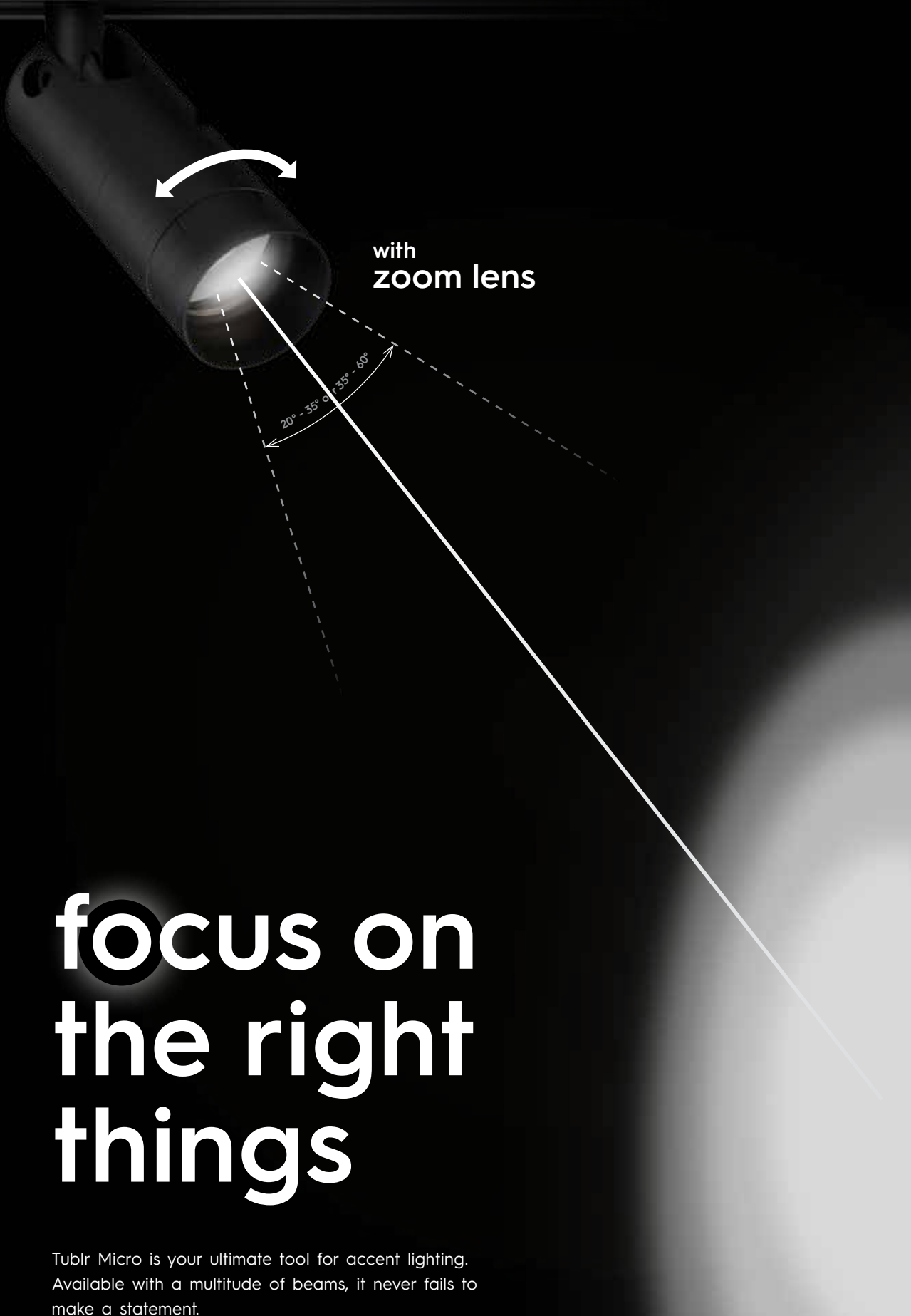

with
zoom lens

20° - 35° or
35° - 60°

focus on the right things

Tublr Micro is your ultimate tool for accent lighting. Available with a multitude of beams, it never fails to make a statement.





fast track >>
to the future >>
of lighting

48V
track
system

the original

spot

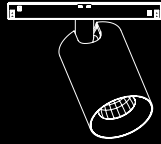

type 1 - tublr medium

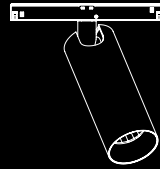

type 1 - tublr mini

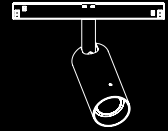

type 2 - tublr micro

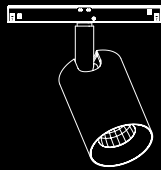

type 2 - tublr medium

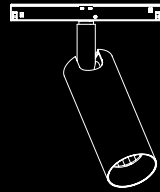

type 2 - tublr mini

linear

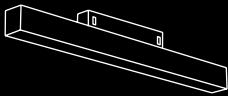

traxx mini

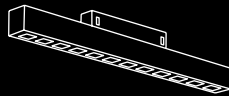

traxx rithm

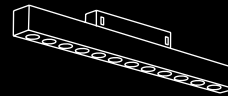

traxx rithm lens

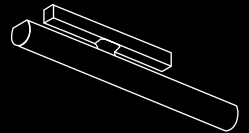

traxx twist

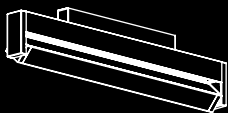

traxx mini tilt

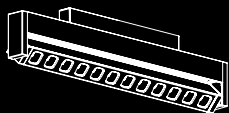

traxx rithm tilt

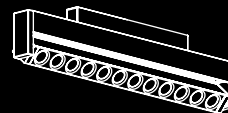

traxx rithm lens tilt

suspension

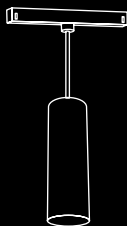

tubed suspension compact

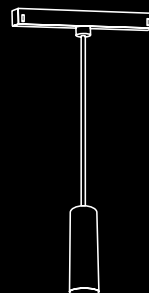

tubed micro suspension

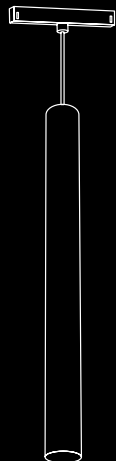

tubed suspension

surface

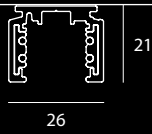

type 1 SA

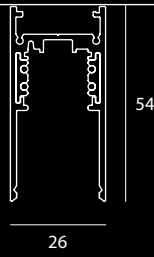

type 2 SB

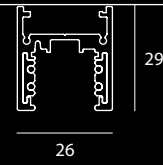

type 1 SB

suspension

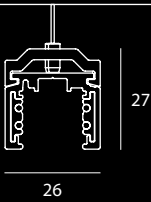

type 1 SA

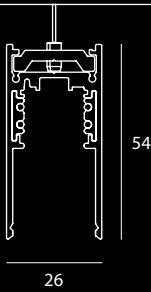

type 2 SB

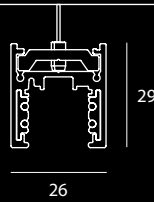

type 2 SB

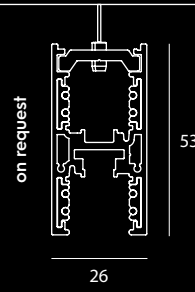

type 1 - 1

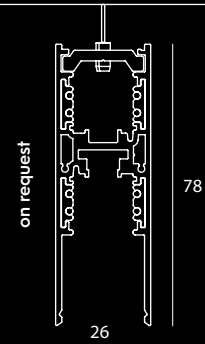

type 1 - 2

recessed - trimless

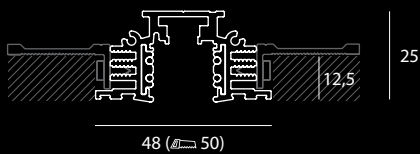

min. installation height: 105 mm

type 1 RA
12.5 mm / 15 mm / 18 mm

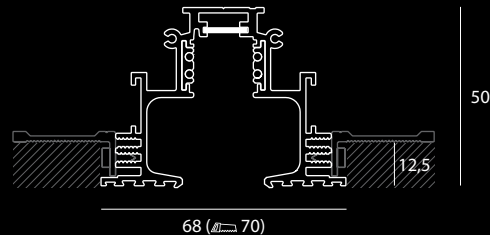

min. installation height: 125 mm

type 2 RA
12.5 mm / 15 mm / 18 mm

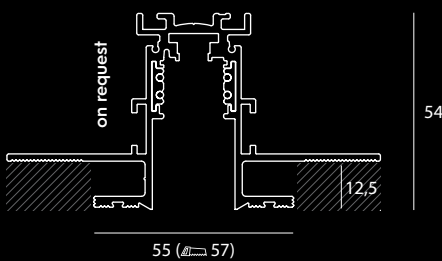

min. installation height: 80 mm

type 2 RC / 12.5 mm

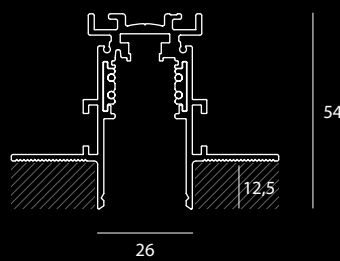

min. installation height: 80 mm
install rail before adding ceiling

type 2 RC / 12.5 mm

recessed - trim

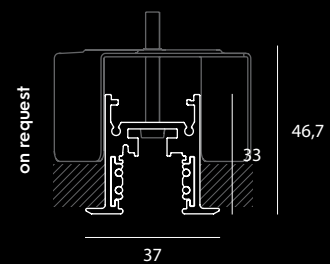

type 1 RT

luminaires



tublr medium

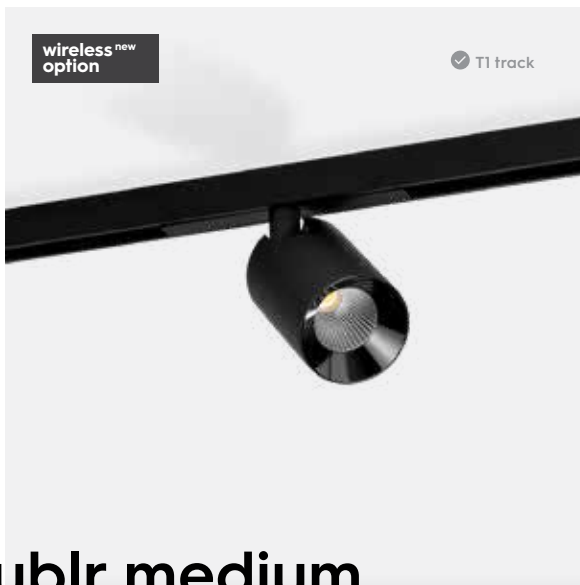

tublr medium 48V track

1x COB LED 1000lm 2700K
48V 11W 1000lm 2700K CRI90+ 24°

replace CLI0_24 for
CLI0_40 40°

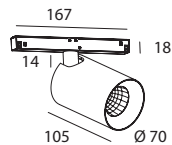

NON-DIM	1 1 1	FO9702IA CLI0_24WW
	1 1 2	FO9702I-2A CLI0_24WW
	1 1 4	FO9702I-4A CLI0_24WW
	1 1 5	FO9702I-5A CLI0_24WW
	1 2 2	FO9702I-2-2A CLI0_24WW
	1 2 1	FO9702I-2-1A CLI0_24WW
	1 2 4	FO9702I-2-4A CLI0_24WW
	1 2 5	FO9702I-2-5A CLI0_24WW
	2 2 2	FO97022A CLI0_24WW
	2 2 1	FO97022-1A CLI0_24WW
	2 2 4	FO97022-4A CLI0_24WW
	2 2 5	FO97022-5A CLI0_24WW
	2 1 2	FO97022-1-2A CLI0_24WW
	2 1 1	FO97022-1-1A CLI0_24WW
	2 1 4	FO97022-1-4A CLI0_24WW
	2 1 5	FO97022-1-5A CLI0_24WW
2 7 2	FO97022-7-2A CLI0_24WW	

HONEYCOMB D50

BS0298

! Wireless dimming available > ref= replace ...D by W
e.g. FO9702ID becomes FO9702IW

1-10V	1 1 1	FO9702IB CLI0_24WW
	1 1 2	FO9702I-2B CLI0_24WW
	1 1 4	FO9702I-4B CLI0_24WW
	1 1 5	FO9702I-5B CLI0_24WW
	1 2 2	FO9702I-2-2B CLI0_24WW
	1 2 1	FO9702I-2-1B CLI0_24WW
	1 2 4	FO9702I-2-4B CLI0_24WW
	1 2 5	FO9702I-2-5B CLI0_24WW
	2 2 2	FO97022B CLI0_24WW
	2 2 1	FO97022-1B CLI0_24WW
	2 2 4	FO97022-4B CLI0_24WW
	2 2 5	FO97022-5B CLI0_24WW
	2 1 2	FO97022-1-2B CLI0_24WW
	2 1 1	FO97022-1-1B CLI0_24WW
	2 1 4	FO97022-1-4B CLI0_24WW
	2 1 5	FO97022-1-5B CLI0_24WW
2 7 2	FO97022-7-2B CLI0_24WW	

DALI	1 1 1	FO9702ID CLI0_24WW
	1 1 2	FO9702I-2D CLI0_24WW
	1 1 4	FO9702I-4D CLI0_24WW
	1 1 5	FO9702I-5D CLI0_24WW
	1 2 2	FO9702I-2-2D CLI0_24WW
	1 2 1	FO9702I-2-1D CLI0_24WW
	1 2 4	FO9702I-2-4D CLI0_24WW
	1 2 5	FO9702I-2-5D CLI0_24WW
	2 2 2	FO97022D CLI0_24WW
	2 2 1	FO97022-1D CLI0_24WW
	2 2 4	FO97022-4D CLI0_24WW
	2 2 5	FO97022-5D CLI0_24WW
	2 1 2	FO97022-1-2D CLI0_24WW
	2 1 1	FO97022-1-1D CLI0_24WW
	2 1 4	FO97022-1-4D CLI0_24WW
	2 1 5	FO97022-1-5D CLI0_24WW
2 7 2	FO97022-7-2D CLI0_24WW	

replace WW for
NW 3000K
MW 3500K
CW 4000K

1	White Structure	5	Dark Chrome
2	Black Structure	6	Gold
4	Gold	7	Champagne

tublr medium

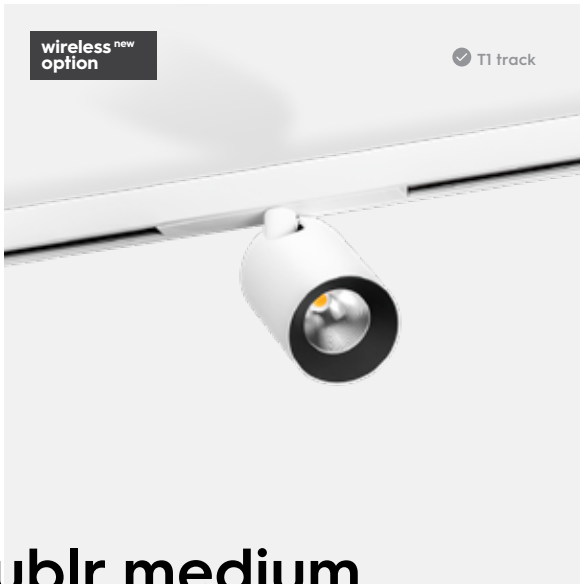

tublr medium 48V track

1x COB LED 600lm 2200K-3000K
48V 6W 600lm 2200K-3000K CRI90+ 40°

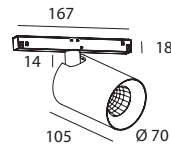

1-10V	1 1 1	FO97021B CL6_40DW
	1 1 2	FO97021-2B CL6_40DW
	1 1 4	FO97021-4B CL6_40DW
	1 1 5	FO97021-5B CL6_40DW
	1 2 2	FO97021-2-2B CL6_40DW
	1 2 1	FO97021-2-1B CL6_40DW
	1 2 4	FO97021-2-4B CL6_40DW
	1 2 5	FO97021-2-5B CL6_40DW
	2 2 2	FO97022B CL6_40DW
	2 2 1	FO97022-1B CL6_40DW
	2 2 4	FO97022-4B CL6_40DW
	2 2 5	FO97022-5B CL6_40DW
	2 1 2	FO97022-1-2B CL6_40DW
	2 1 1	FO97022-1-1B CL6_40DW
	2 1 4	FO97022-1-4B CL6_40DW
	2 1 5	FO97022-1-5B CL6_40DW
	2 7 2	FO97022-7-2B CL6_40DW

HONEYCOMB D50

BS0298

! Wireless dimming available > ref= replace ...D by W
e.g. FO97021B becomes FO97021W

DALI	1 1 1	FO97021D CL6_40DW
	1 1 2	FO97021-2D CL6_40DW
	1 1 4	FO97021-4D CL6_40DW
	1 1 5	FO97021-5D CL6_40DW
	1 2 2	FO97021-2-2D CL6_40DW
	1 2 1	FO97021-2-1D CL6_40DW
	1 2 4	FO97021-2-4D CL6_40DW
	1 2 5	FO97021-2-5D CL6_40DW
	2 2 2	FO97022D CL6_40DW
	2 2 1	FO97022-1D CL6_40DW
	2 2 4	FO97022-4D CL6_40DW
	2 2 5	FO97022-5D CL6_40DW
	2 1 2	FO97022-1-2D CL6_40DW
	2 1 1	FO97022-1-1D CL6_40DW
	2 1 4	FO97022-1-4D CL6_40DW
	2 1 5	FO97022-1-5D CL6_40DW
	2 7 2	FO97022-7-2D CL6_40DW

1 White Structure

2 Black Structure

4 Gold

5 Dark Chrome

7 Champagne

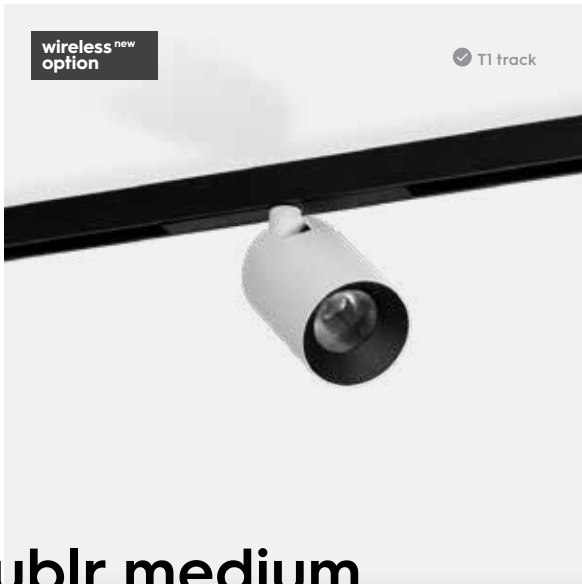

tublr medium

48V track

1x COB LED LENS 800lm 2700K
48V 9W 800lm 2700K CRI90+ 12°

replace CL8L12 for
CL8L15 15°
CL8L30 30°
CL8L40 40°

NON-DIM	1 1 1	FO97021A CL8L12WW
	1 1 2	FO97021-2A CL8L12WW
	1 1 4	FO97021-4A CL8L12WW
	1 1 5	FO97021-5A CL8L12WW
	1 2 2	FO97021-2-2A CL8L12WW
	1 2 1	FO97021-2-1A CL8L12WW
	1 2 4	FO97021-2-4A CL8L12WW
	1 2 5	FO97021-2-5A CL8L12WW
	2 2 2	FO97022A CL8L12WW
	2 2 1	FO97022-1A CL8L12WW
	2 2 4	FO97022-4A CL8L12WW
	2 2 5	FO97022-5A CL8L12WW
	2 1 2	FO97022-1-2A CL8L12WW
	2 1 1	FO97022-1-1A CL8L12WW
	2 1 4	FO97022-1-4A CL8L12WW
	2 1 5	FO97022-1-5A CL8L12WW
	2 7 2	FO97022-7-2A CL8L12WW

HONEYCOMB D50

BS0298

! Wireless dimming available > ref= replace ...A by W
e.g. FO97021A becomes FO97021W

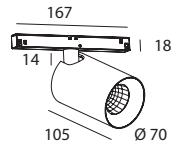

1-10V	1 1 1	FO97021B CL8L12WW
	1 1 2	FO97021-2B CL8L12WW
	1 1 4	FO97021-4B CL8L12WW
	1 1 5	FO97021-5B CL8L12WW
	1 2 2	FO97021-2-2B CL8L12WW
	1 2 1	FO97021-2-1B CL8L12WW
	1 2 4	FO97021-2-4B CL8L12WW
	1 2 5	FO97021-2-5B CL8L12WW
	2 2 2	FO97022B CL8L12WW
	2 2 1	FO97022-1B CL8L12WW
	2 2 4	FO97022-4B CL8L12WW
	2 2 5	FO97022-5B CL8L12WW
	2 1 2	FO97022-1-2B CL8L12WW
	2 1 1	FO97022-1-1B CL8L12WW
	2 1 4	FO97022-1-4B CL8L12WW
2 1 5	FO97022-1-5B CL8L12WW	
2 7 2	FO97022-7-2B CL8L12WW	

DALI	1 1 1	FO97021D CL8L12WW
	1 1 2	FO97021-2D CL8L12WW
	1 1 4	FO97021-4D CL8L12WW
	1 1 5	FO97021-5D CL8L12WW
	1 2 2	FO97021-2-2D CL8L12WW
	1 2 1	FO97021-2-1D CL8L12WW
	1 2 4	FO97021-2-4D CL8L12WW
	1 2 5	FO97021-2-5D CL8L12WW
	2 2 2	FO97022D CL8L12WW
	2 2 1	FO97022-1D CL8L12WW
	2 2 4	FO97022-4D CL8L12WW
	2 2 5	FO97022-5D CL8L12WW
	2 1 2	FO97022-1-2D CL8L12WW
	2 1 1	FO97022-1-1D CL8L12WW
	2 1 4	FO97022-1-4D CL8L12WW
2 1 5	FO97022-1-5D CL8L12WW	
2 7 2	FO97022-7-2D CL8L12WW	

replace WW for
NW 3000K
MW 3500K
CW 4000K

1	White Structure	5	Dark Chrome
2	Black Structure	6	Gold
4	Gold	7	Champagne

tublr medium

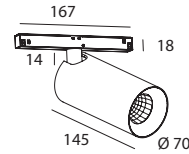
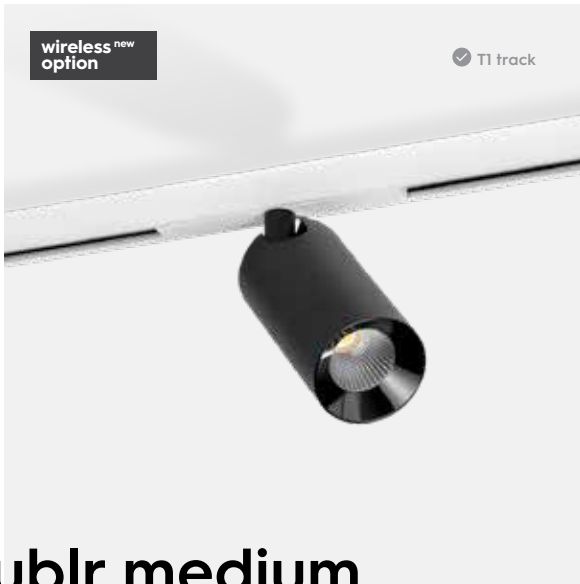

tublr medium 48V track

1x COB LED 2000lm 2700K
48V 17W 2000lm 2700K CRI90+ 24°

replace CLI0_24 for
CLI0_40 40°

NON-DIM	1 1 1	FO97021A CL20_24WW
	1 1 2	FO97021-2A CL20_24WW
	1 1 4	FO97021-4A CL20_24WW
	1 1 5	FO97021-5A CL20_24WW
	1 2 2	FO97021-2-2A CL20_24WW
	1 2 1	FO97021-2-1A CL20_24WW
	1 2 4	FO97021-2-4A CL20_24WW
	1 2 5	FO97021-2-5A CL20_24WW
	2 2 2	FO97022A CL20_24WW
	2 2 1	FO97022-1A CL20_24WW
	2 2 4	FO97022-4A CL20_24WW
	2 2 5	FO97022-5A CL20_24WW
	2 1 2	FO97022-1-2A CL20_24WW
	2 1 1	FO97022-1-1A CL20_24WW
	2 1 4	FO97022-1-4A CL20_24WW
	2 1 5	FO97022-1-5A CL20_24WW
2 7 2	FO97022-7-2A CL20_24WW	

HONEYCOMB D50

BS0298

! Wireless dimming available > ref= replace ...D by W
e.g. FO97021D becomes FO97021W

I-10V	1 1 1	FO97021B CL20_24WW
	1 1 2	FO97021-2B CL20_24WW
	1 1 4	FO97021-4B CL20_24WW
	1 1 5	FO97021-5B CL20_24WW
	1 2 2	FO97021-2-2B CL20_24WW
	1 2 1	FO97021-2-1B CL20_24WW
	1 2 4	FO97021-2-4B CL20_24WW
	1 2 5	FO97021-2-5B CL20_24WW
	2 2 2	FO97022B CL20_24WW
	2 2 1	FO97022-1B CL20_24WW
	2 2 4	FO97022-4B CL20_24WW
	2 2 5	FO97022-5B CL20_24WW
	2 1 2	FO97022-1-2B CL20_24WW
	2 1 1	FO97022-1-1B CL20_24WW
2 1 4	FO97022-1-4B CL20_24WW	
2 1 5	FO97022-1-5B CL20_24WW	
2 7 2	FO97022-7-2B CL20_24WW	

DALI	1 1 1	FO97021D CL20_24WW
	1 1 2	FO97021-2D CL20_24WW
	1 1 4	FO97021-4D CL20_24WW
	1 1 5	FO97021-5D CL20_24WW
	1 2 2	FO97021-2-2D CL20_24WW
	1 2 1	FO97021-2-1D CL20_24WW
	1 2 4	FO97021-2-4D CL20_24WW
	1 2 5	FO97021-2-5D CL20_24WW
	2 2 2	FO97022D CL20_24WW
	2 2 1	FO97022-1D CL20_24WW
	2 2 4	FO97022-4D CL20_24WW
	2 2 5	FO97022-5D CL20_24WW
	2 1 2	FO97022-1-2D CL20_24WW
	2 1 1	FO97022-1-1D CL20_24WW
	2 1 4	FO97022-1-4D CL20_24WW
	2 1 5	FO97022-1-5D CL20_24WW
2 7 2	FO97022-7-2D CL20_24WW	

replace WW for
NW 3000K
MW 3500K
CW 4000K

- 1 White Structure
- 2 Black Structure
- 4 Gold
- 5 Dark Chrome
- 7 Champagne

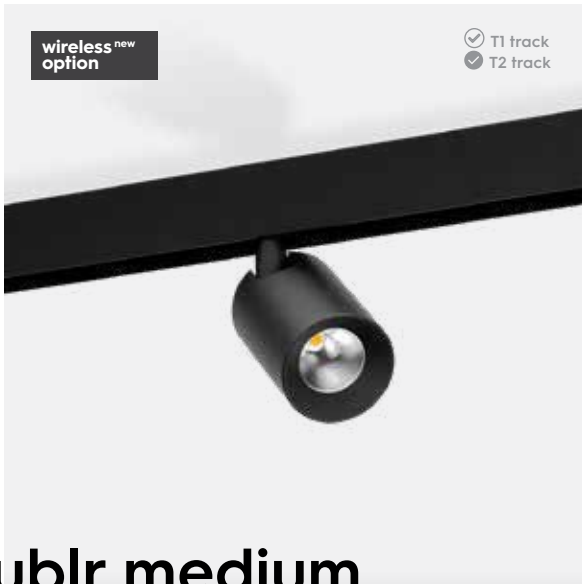

tublr medium

48V track

1x COB LED 1000lm 2700K
48V 11W 1000lm 2700K CRI90+ 24°

replace CLI0_24 for
CLI0_40 40°

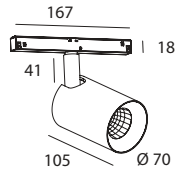

NON-DIM	1 1 1	FO9802IA CLI0_24WW
	1 1 2	FO9802I-2A CLI0_24WW
	1 1 4	FO9802I-4A CLI0_24WW
	1 1 5	FO9802I-5A CLI0_24WW
	1 2 2	FO9802I-2-2A CLI0_24WW
	1 2 1	FO9802I-2-1A CLI0_24WW
	1 2 4	FO9802I-2-4A CLI0_24WW
	1 2 5	FO9802I-2-5A CLI0_24WW
	2 2 2	FO98022A CLI0_24WW
	2 2 1	FO98022-1A CLI0_24WW
	2 2 4	FO98022-4A CLI0_24WW
	2 2 5	FO98022-5A CLI0_24WW
	2 1 2	FO98022-1-2A CLI0_24WW
	2 1 1	FO98022-1-1A CLI0_24WW
	2 1 4	FO98022-1-4A CLI0_24WW
	2 1 5	FO98022-1-5A CLI0_24WW
2 7 2	FO98022-7-2A CLI0_24WW	

HONEYCOMB D50

BS0298

! Wireless dimming available > ref= replace ...A by W
e.g. FO9802IA becomes FO9702IW

1-10V

1 1 1	FO9802IB CLI0_24WW
1 1 2	FO98 02I-2B CLI0_24WW
1 1 4	FO9802I-4B CLI0_24WW
1 1 5	FO9802I-5B CLI0_24WW
1 2 2	FO9802I-2-2B CLI0_24WW
1 2 1	FO9802I-2-1B CLI0_24WW
1 2 4	FO9802I-2-4B CLI0_24WW
1 2 5	FO9802I-2-5B CLI0_24WW
2 2 2	FO98022B CLI0_24WW
2 2 1	FO98022-1B CLI0_24WW
2 2 4	FO98022-4B CLI0_24WW
2 2 5	FO98022-5B CLI0_24WW
2 1 2	FO98022-1-2B CLI0_24WW
2 1 1	FO98022-1-1B CLI0_24WW
2 1 4	FO98022-1-4B CLI0_24WW
2 1 5	FO98022-1-5B CLI0_24WW
2 7 2	FO98022-7-2B CLI0_24WW

DALI

1 1 1	FO9802ID CLI0_24WW
1 1 2	FO9802I-2D CLI0_24WW
1 1 4	FO9802I-4D CLI0_24WW
1 1 5	FO9802I-5D CLI0_24WW
1 2 2	FO9802I-2-2D CLI0_24WW
1 2 1	FO9802I-2-1D CLI0_24WW
1 2 4	FO9802I-2-4D CLI0_24WW
1 2 5	FO9802I-2-5D CLI0_24WW
2 2 2	FO98022D CLI0_24WW
2 2 1	FO98022-1D CLI0_24WW
2 2 4	FO98022-4D CLI0_24WW
2 2 5	FO98022-5D CLI0_24WW
2 1 2	FO98022-1-2D CLI0_24WW
2 1 1	FO98022-1-1D CLI0_24WW
2 1 4	FO98022-1-4D CLI0_24WW
2 1 5	FO98022-1-5D CLI0_24WW
2 7 2	FO98022-7-2D CLI0_24WW

replace WW for
NW 3000K
MW 3500K
CW 4000K

1	White Structure	5	Dark Chrome
2	Black Structure	6	Gold
4	Gold	7	Champagne

tublr medium

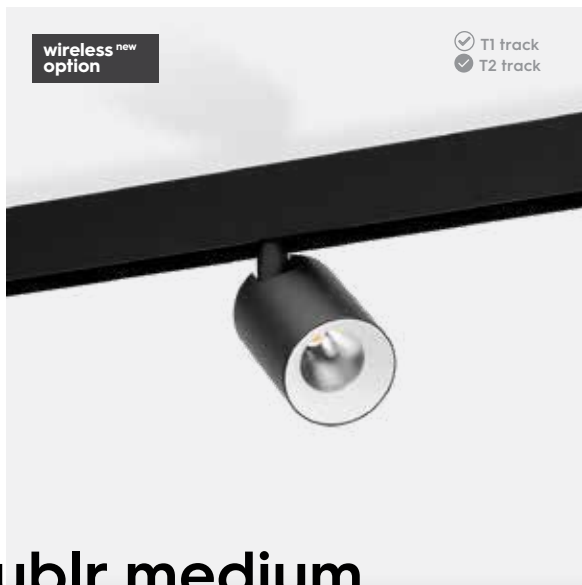

tublr medium

48V track

1x COB LED 600lm 2200K-3000K
48V 6W 600lm 2200K-3000K CRI90+ 40°

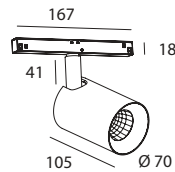

1-10V	Color Code	Model
1 1 1		FO98021B CL6_40DW
1 1 2		FO98021-2B CL6_40DW
1 1 4		FO98021-4B CL6_40DW
1 1 5		FO98021-5B CL6_40DW
1 2 2		FO98021-2-2B CL6_40DW
1 2 1		FO98021-2-1B CL6_40DW
1 2 4		FO98021-2-4B CL6_40DW
1 2 5		FO98021-2-5B CL6_40DW
2 2 2		FO98022B CL6_40DW
2 2 1		FO98022-1B CL6_40DW
2 2 4		FO98022-4B CL6_40DW
2 2 5		FO98022-5B CL6_40DW
2 1 2		FO98022-1-2B CL6_40DW
2 1 1		FO98022-1-1B CL6_40DW
2 1 4		FO98022-1-4B CL6_40DW
2 1 5		FO98022-1-5B CL6_40DW
2 7 2		FO98022-7-2B CL6_40DW

HONEYCOMB D50

BS0298

! Wireless dimming available > ref= replace ...D by W
e.g. FO98021B becomes FO97021W

DALI	Color Code	Model
1 1 1		FO98021D CL6_40DW
1 1 2		FO98021-2D CL6_40DW
1 1 4		FO98021-4D CL6_40DW
1 1 5		FO98021-5D CL6_40DW
1 2 2		FO98021-2-2D CL6_40DW
1 2 1		FO98021-2-1D CL6_40DW
1 2 4		FO98021-2-4D CL6_40DW
1 2 5		FO98021-2-5D CL6_40DW
2 2 2		FO98022D CL6_40DW
2 2 1		FO98022-1D CL6_40DW
2 2 4		FO98022-4D CL6_40DW
2 2 5		FO98022-5D CL6_40DW
2 1 2		FO98022-1-2D CL6_40DW
2 1 1		FO98022-1-1D CL6_40DW
2 1 4		FO98022-1-4D CL6_40DW
2 1 5		FO98022-1-5D CL6_40DW
2 7 2		FO98022-7-2D CL6_40DW

1 White Structure

2 Black Structure

4 Gold

5 Dark Chrome

7 Champagne

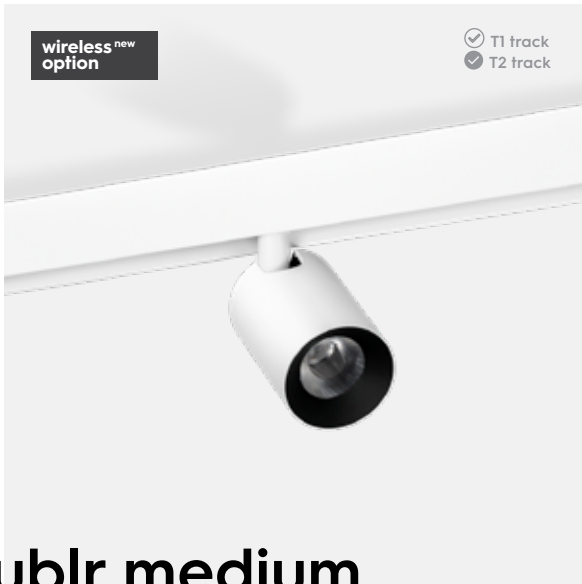

tublr medium

48V track

1x COB LED LENS 800lm 2700K
48V 9W 800lm 2700K CRI90+ 12°

replace CL8L12 for
CL8L15 15°
CL8L30 30°
CL8L40 40°

NON-DIM	1 1 1	FO98021A CL8L12WW
	1 1 2	FO98021-2A CL8L12WW
	1 1 4	FO98021-4A CL8L12WW
	1 1 5	FO98021-5A CL8L12WW
	1 2 2	FO98021-2-2A CL8L12WW
	1 2 1	FO98021-2-1A CL8L12WW
	1 2 4	FO98021-2-4A CL8L12WW
	1 2 5	FO98021-2-5A CL8L12WW
	2 2 2	FO98022A CL8L12WW
	2 2 1	FO98022-1A CL8L12WW
	2 2 4	FO98022-4A CL8L12WW
	2 2 5	FO98022-5A CL8L12WW
	2 1 2	FO98022-1-2A CL8L12WW
	2 1 1	FO98022-1-1A CL8L12WW
	2 1 4	FO98022-1-4A CL8L12WW
	2 1 5	FO98022-1-5A CL8L12WW
	2 7 2	FO98022-7-2A CL8L12WW

HONEYCOMB D50

BS0298

! Wireless dimming available > ref= replace ...A by W
e.g. FO98021A becomes FO97021W

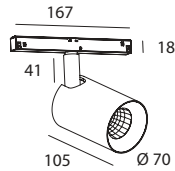

1-10V	1 1 1	FO98021B CL8L12WW
	1 1 2	FO98 021-2B CL8L12WW
	1 1 4	FO98021-4B CL8L12WW
	1 1 5	FO98021-5B CL8L12WW
	1 2 2	FO98021-2-2B CL8L12WW
	1 2 1	FO98021-2-1B CL8L12WW
	1 2 4	FO98021-2-4B CL8L12WW
	1 2 5	FO98021-2-5B CL8L12WW
	2 2 2	FO98022B CL8L12WW
	2 2 1	FO98022-1B CL8L12WW
	2 2 4	FO98022-4B CL8L12WW
	2 2 5	FO98022-5B CL8L12WW
	2 1 2	FO98022-1-2B CL8L12WW
	2 1 1	FO98022-1-1B CL8L12WW
	2 1 4	FO98022-1-4B CL8L12WW
	2 1 5	FO98022-1-5B CL8L12WW
	2 7 2	FO98022-7-2B CL8L12WW

DALI	1 1 1	FO98021D CL8L12WW
	1 1 2	FO98021-2D CL8L12WW
	1 1 4	FO98021-4D CL8L12WW
	1 1 5	FO98021-5D CL8L12WW
	1 2 2	FO98021-2-2D CL8L12WW
	1 2 1	FO98021-2-1D CL8L12WW
	1 2 4	FO98021-2-4D CL8L12WW
	1 2 5	FO98021-2-5D CL8L12WW
	2 2 2	FO98022D CL8L12WW
	2 2 1	FO98022-1D CL8L12WW
	2 2 4	FO98022-4D CL8L12WW
	2 2 5	FO98022-5D CL8L12WW
	2 1 2	FO98022-1-2D CL8L12WW
	2 1 1	FO98022-1-1D CL8L12WW
	2 1 4	FO98022-1-4D CL8L12WW
	2 1 5	FO98022-1-5D CL8L12WW
	2 7 2	FO98022-7-2D CL8L12WW

replace WW for
NW 3000K
MW 3500K
CW 4000K

1	White Structure	5	Dark Chrome
2	Black Structure	6	Gold
4	Gold	7	Champagne

tublr medium

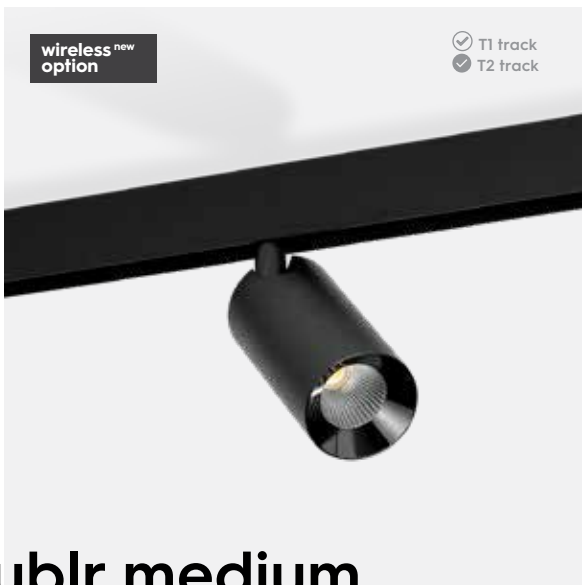

tublr medium 48V track

1x COB LED 2000lm 2700K
48V 17W 2000lm 2700K CRI90+ 24°

replace CLI0_24 for
CLI0_40 40°

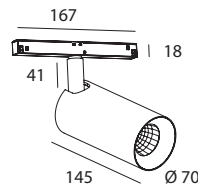

NON-DIM	1 1 1	FO98021A CL20_24WW
	1 1 2	FO98021-2A CL20_24WW
	1 1 4	FO98021-4A CL20_24WW
	1 1 5	FO98021-5A CL20_24WW
	1 2 2	FO98021-2-2A CL20_24WW
	1 2 1	FO98021-2-1A CL20_24WW
	1 2 4	FO98021-2-4A CL20_24WW
	1 2 5	FO98021-2-5A CL20_24WW
	2 2 2	FO98022A CL20_24WW
	2 2 1	FO98022-1A CL20_24WW
	2 2 4	FO98022-4A CL20_24WW
	2 2 5	FO98022-5A CL20_24WW
	2 1 2	FO98022-1-2A CL20_24WW
	2 1 1	FO98022-1-1A CL20_24WW
	2 1 4	FO98022-1-4A CL20_24WW
	2 1 5	FO98022-1-5A CL20_24WW
2 7 2	FO98022-7-2A CL20_24WW	

HONEYCOMB D50

BS0298

! Wireless dimming available > ref= replace ...D by W
e.g. FO97021D becomes FO97021W

1-10V	1 1 1	FO98021B CL20_24WW
	1 1 2	FO98021-2B CL20_24WW
	1 1 4	FO98021-4B CL20_24WW
	1 1 5	FO98021-5B CL20_24WW
	1 2 2	FO98021-2-2B CL20_24WW
	1 2 1	FO98021-2-1B CL20_24WW
	1 2 4	FO98021-2-4B CL20_24WW
	1 2 5	FO98021-2-5B CL20_24WW
	2 2 2	FO98022B CL20_24WW
	2 2 1	FO98022-1B CL20_24WW
	2 2 4	FO98022-4B CL20_24WW
	2 2 5	FO98022-5B CL20_24WW
	2 1 2	FO98022-1-2B CL20_24WW
	2 1 1	FO98022-1-1B CL20_24WW
2 1 4	FO98022-1-4B CL20_24WW	
2 1 5	FO98022-1-5B CL20_24WW	
2 7 2	FO98022-7-2B CL20_24WW	

DALI	1 1 1	FO98021D CL20_24WW
	1 1 2	FO98021-2D CL20_24WW
	1 1 4	FO98021-4D CL20_24WW
	1 1 5	FO98021-5D CL20_24WW
	1 2 2	FO98021-2-2D CL20_24WW
	1 2 1	FO98021-2-1D CL20_24WW
	1 2 4	FO98021-2-4D CL20_24WW
	1 2 5	FO98021-2-5D CL20_24WW
	2 2 2	FO98022D CL20_24WW
	2 2 1	FO98022-1D CL20_24WW
	2 2 4	FO98022-4D CL20_24WW
	2 2 5	FO98022-5D CL20_24WW
	2 1 2	FO98022-1-2D CL20_24WW
	2 1 1	FO98022-1-1D CL20_24WW
	2 1 4	FO98022-1-4D CL20_24WW
	2 1 5	FO98022-1-5D CL20_24WW
2 7 2	FO98022-7-2D CL20_24WW	

replace WW for
NW 3000K
MW 3500K
CW 4000K

- 1 White Structure
- 2 Black Structure
- 4 Gold
- 5 Dark Chrome
- 7 Champagne



90° horizontal
standard joint

angular horizontal
joint on request

90° vertical joint
on request

angular
vertical joint
on request

**Get creative
with custom
angles**

tublr mini

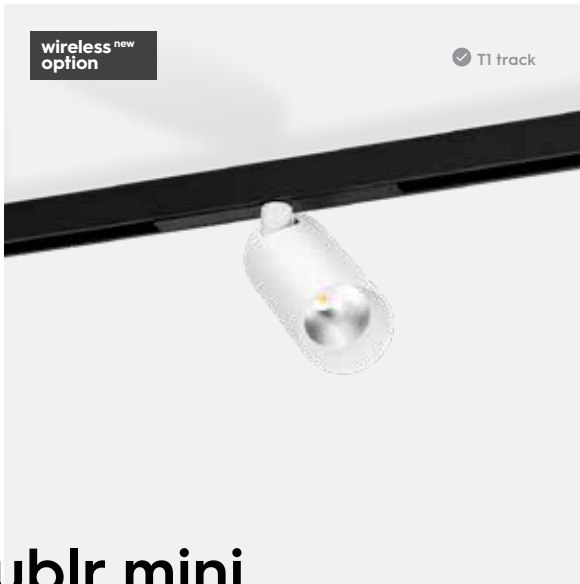

tublr mini 48V track

1x COB LED 1000lm 2700K
48V 10W 1000lm 2700K CRI90+ 24°

replace CLI0_24 for
CLI0_40 40°

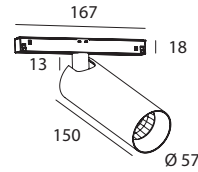

NON-DIM	1 1 1	FO97031A CLI0_24WW
	1 1 2	FO97031-2A CLI0_24WW
	1 1 4	FO97031-4A CLI0_24WW
	1 1 5	FO97031-5A CLI0_24WW
	1 2 2	FO97031-2-2A CLI0_24WW
	1 2 1	FO97031-2-1A CLI0_24WW
	1 2 4	FO97031-2-4A CLI0_24WW
	1 2 5	FO97031-2-5A CLI0_24WW
	2 2 2	FO97032A CLI0_24WW
	2 2 1	FO97032-1A CLI0_24WW
	2 2 4	FO97032-4A CLI0_24WW
	2 2 5	FO97032-5A CLI0_24WW
	2 1 2	FO97032-1-2A CLI0_24WW
	2 1 1	FO97032-1-1A CLI0_24WW
	2 1 4	FO97032-1-4A CLI0_24WW
	2 1 5	FO97032-1-5A CLI0_24WW
	2 7 2	FO97032-7-2A CLI0_24WW

HONEYCOMB D50

BS0298

! Wireless dimming available > ref= replace ...D by W
e.g. FO97021D becomes FO97021W

1-10V	1 1 1	FO97031B CLI0_24WW
	1 1 2	FO97031-2B CLI0_24WW
	1 1 4	FO97031-4B CLI0_24WW
	1 1 5	FO97031-5B CLI0_24WW
	1 2 2	FO97031-2-2B CLI0_24WW
	1 2 1	FO97031-2-1B CLI0_24WW
	1 2 4	FO97031-2-4B CLI0_24WW
	1 2 5	FO97031-2-5B CLI0_24WW
	2 2 2	FO97032B CLI0_24WW
	2 2 1	FO97032-1B CLI0_24WW
	2 2 4	FO97032-4B CLI0_24WW
	2 2 5	FO97032-5B CLI0_24WW
	2 1 2	FO97032-1-2B CLI0_24WW
	2 1 1	FO97032-1-1B CLI0_24WW
	2 1 4	FO97032-1-4B CLI0_24WW
2 1 5	FO97032-1-5B CLI0_24WW	
2 7 2	FO97032-7-2B CLI0_24WW	

DALI	1 1 1	FO97031D CLI0_24WW
	1 1 2	FO97031-2D CLI0_24WW
	1 1 4	FO97031-4D CLI0_24WW
	1 1 5	FO97031-5D CLI0_24WW
	1 2 2	FO97031-2-2D CLI0_24WW
	1 2 1	FO97031-2-1D CLI0_24WW
	1 2 4	FO97031-2-4D CLI0_24WW
	1 2 5	FO97031-2-5D CLI0_24WW
	2 2 2	FO97032D CLI0_24WW
	2 2 1	FO97032-1D CLI0_24WW
	2 2 4	FO97032-4D CLI0_24WW
	2 2 5	FO97032-5D CLI0_24WW
	2 1 2	FO97032-1-2D CLI0_24WW
	2 1 1	FO97032-1-1D CLI0_24WW
	2 1 4	FO97032-1-4D CLI0_24WW
2 1 5	FO97032-1-5D CLI0_24WW	
2 7 2	FO97032-7-2D CLI0_24WW	

replace WW for
NW 3000K
MW 3500K
CW 4000K

- 1 White Structure
- 2 Black Structure
- 4 Gold
- 5 Dark Chrome
- 7 Champagne

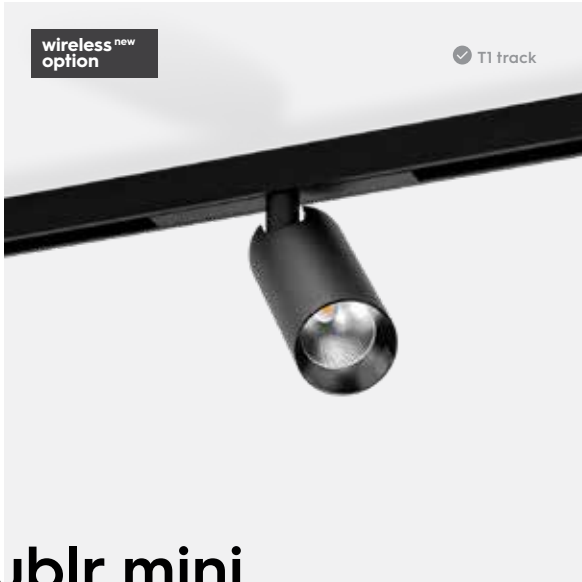

tublr mini

48V track

1x COB LED 600lm 2200K-3000K
48V 6W 600lm 2200K-3000K CRI90+ 40°

1-10V	1 1 1	FO97031B CL6_40DW
	1 1 2	FO97031-2B CL6_40DW
	1 1 4	FO97031-4B CL6_40DW
	1 1 5	FO97031-5B CL6_40DW
	1 2 2	FO97031-2-2B CL6_40DW
	1 2 1	FO97031-2-1B CL6_40DW
	1 2 4	FO97031-2-4B CL6_40DW
	1 2 5	FO97031-2-5B CL6_40DW
	2 2 2	FO97032B CL6_40DW
	2 2 1	FO97032-1B CL6_40DW
	2 2 4	FO97032-4B CL6_40DW
	2 2 5	FO97032-5B CL6_40DW
	2 1 2	FO97032-1-2B CL6_40DW
	2 1 1	FO97032-1-1B CL6_40DW
	2 1 4	FO97032-1-4B CL6_40DW
	2 1 5	FO97032-1-5B CL6_40DW
2 7 2	FO97032-7-2B CL6_40DW	

HONEYCOMB D50

BS0298

! Wireless dimming available > ref= replace ...D by W
e.g. FO98021B becomes FO97021W

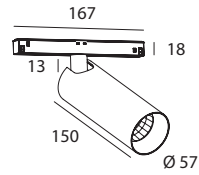

DALI	1 1 1	FO97031D CL6_40DW
	1 1 2	FO97031-2D CL6_40DW
	1 1 4	FO97031-4D CL6_40DW
	1 1 5	FO97031-5D CL6_40DW
	1 2 2	FO97031-2-2D CL6_40DW
	1 2 1	FO97031-2-1D CL6_40DW
	1 2 4	FO97031-2-4D CL6_40DW
	1 2 5	FO97031-2-5D CL6_40DW
	2 2 2	FO97032D CL6_40DW
	2 2 1	FO97032-1D CL6_40DW
	2 2 4	FO97032-4D CL6_40DW
	2 2 5	FO97032-5D CL6_40DW
	2 1 2	FO97032-1-2D CL6_40DW
	2 1 1	FO97032-1-1D CL6_40DW
	2 1 4	FO97032-1-4D CL6_40DW
	2 1 5	FO97032-1-5D CL6_40DW
2 7 2	FO97032-7-2D CL6_40DW	

1 White Structure

2 Black Structure

4 Gold

5 Dark Chrome

7 Champagne

tublr mini

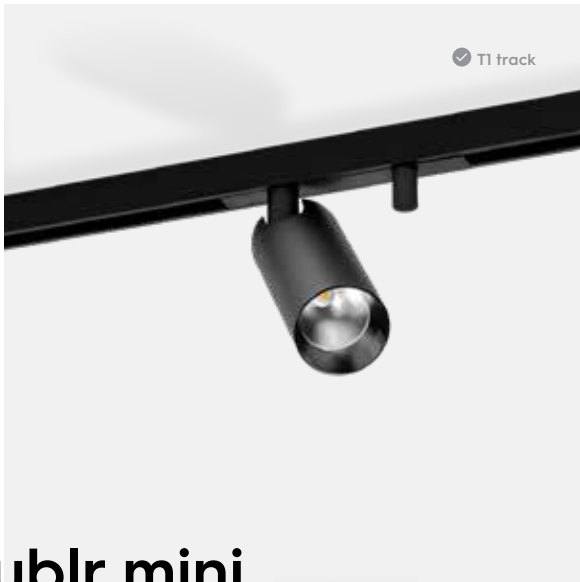

tublr mini

48V track

1x COB LED 1000lm 2700K
48V 10W 1000lm 2700K CRI90+ 40°

replace CLI0_24 for
CLI0_40 40°

WITH DIMMING KNOB	2 2 2	FO97032P CLI0_24WW
	2 2 1	FO97032-1P CLI0_24WW
	2 2 4	FO97032-4P CLI0_24WW
	2 2 5	FO97032-5P CLI0_24WW
	2 1 2	FO97032-1-2P CLI0_24WW
	2 1 1	FO97032-1-1P CLI0_24WW
	2 1 4	FO97032-1-4P CLI0_24WW
	2 1 5	FO97032-1-5P CLI0_24WW
	2 7 2	FO97032-7-2P CLI0_24WW

HONEYCOMB D50

BS0298

replace WW for
NW 3000K
MW 3500K
CW 4000K

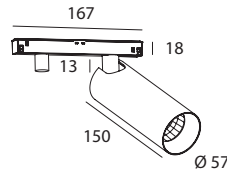

1x COB LED 600lm 2200K-3000K
48V 6W 600lm 2200K-3000K CRI90+ 40°

WITH DIMMING KNOB	2 2 2	FO97032P CL6_40DW
	2 2 1	FO97032-1P CL6_40DW
	2 2 4	FO97032-4P CL6_40DW
	2 2 5	FO97032-5P CL6_40DW
	2 1 2	FO97032-1-2P CL6_40DW
	2 1 1	FO97032-1-1P CL6_40DW
	2 1 4	FO97032-1-4P CL6_40DW
	2 1 5	FO97032-1-5P CL6_40DW
	2 7 2	FO97032-7-2P CL6_40DW

HONEYCOMB D50

BS0298

1 White Structure

2 Black Structure

4 Gold

5 Dark Chrome

7 Champagne

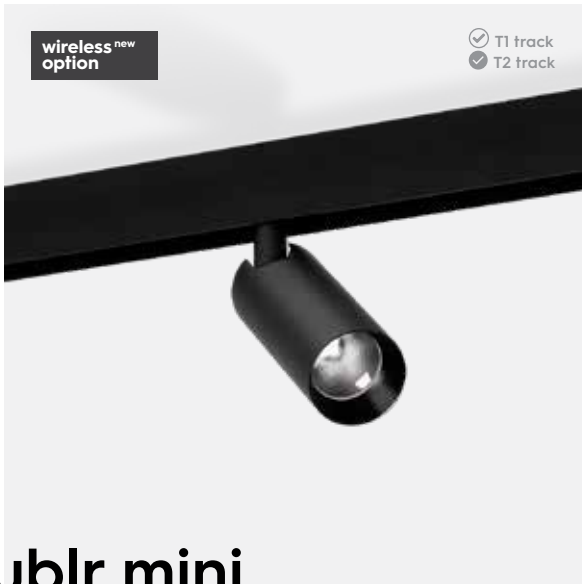

tublr mini

48V track

1x COB LED 1000lm 2700K
48V 10W 1000lm 2700K CRI90+ 24°

replace CLI0_24 for
CLI0_40 40°

NON-DIM	1 1 1	FO98031A CLI0_24WW
	1 1 2	FO98031-2A CLI0_24WW
	1 1 4	FO98031-4A CLI0_24WW
	1 1 5	FO98031-5A CLI0_24WW
	1 2 2	FO98031-2-2A CLI0_24WW
	1 2 1	FO98031-2-1A CLI0_24WW
	1 2 4	FO98031-2-4A CLI0_24WW
	1 2 5	FO98031-2-5A CLI0_24WW
	2 2 2	FO98032A CLI0_24WW
	2 2 1	FO98032-1A CLI0_24WW
	2 2 4	FO98032-4A CLI0_24WW
	2 2 5	FO98032-5A CLI0_24WW
	2 1 2	FO98032-1-2A CLI0_24WW
	2 1 1	FO98032-1-1A CLI0_24WW
	2 1 4	FO98032-1-4A CLI0_24WW
	2 1 5	FO98032-1-5A CLI0_24WW
2 7 2	FO98032-7-2A CLI0_24WW	

HONEYCOMB D50

BS0298

! Wireless dimming available > ref= replace ...D by W
e.g. FO97021D becomes FO97021W

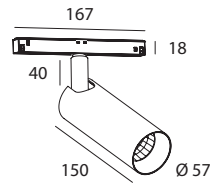

1-10V	1 1 1	FO98031B CLI0_24WW
	1 1 2	FO98031-2B CLI0_24WW
	1 1 4	FO98031-4B CLI0_24WW
	1 1 5	FO98031-5B CLI0_24WW
	1 2 2	FO98031-2-2B CLI0_24WW
	1 2 1	FO98031-2-1B CLI0_24WW
	1 2 4	FO98031-2-4B CLI0_24WW
	1 2 5	FO98031-2-5B CLI0_24WW
	2 2 2	FO98032B CLI0_24WW
	2 2 1	FO98032-1B CLI0_24WW
	2 2 4	FO98032-4B CLI0_24WW
	2 2 5	FO98032-5B CLI0_24WW
	2 1 2	FO98032-1-2B CLI0_24WW
	2 1 1	FO98032-1-1B CLI0_24WW
	2 1 4	FO98032-1-4B CLI0_24WW
	2 1 5	FO98032-1-5B CLI0_24WW
2 7 2	FO98032-7-2B CLI0_24WW	

DALI	1 1 1	FO98031D CLI0_24WW
	1 1 2	FO98031-2D CLI0_24WW
	1 1 4	FO98031-4D CLI0_24WW
	1 1 5	FO98031-5D CLI0_24WW
	1 2 2	FO98031-2-2D CLI0_24WW
	1 2 1	FO98031-2-1D CLI0_24WW
	1 2 4	FO98031-2-4D CLI0_24WW
	1 2 5	FO98031-2-5D CLI0_24WW
	2 2 2	FO98032D CLI0_24WW
	2 2 1	FO98032-1D CLI0_24WW
	2 2 4	FO98032-4D CLI0_24WW
	2 2 5	FO98032-5D CLI0_24WW
	2 1 2	FO98032-1-2D CLI0_24WW
	2 1 1	FO98032-1-1D CLI0_24WW
	2 1 4	FO98032-1-4D CLI0_24WW
	2 1 5	FO98032-1-5D CLI0_24WW
2 7 2	FO98032-7-2D CLI0_24WW	

replace WW for
NW 3000K
MW 3500K
CW 4000K

1	White Structure	5	Dark Chrome
2	Black Structure	7	Champagne
4	Gold		

tublr mini

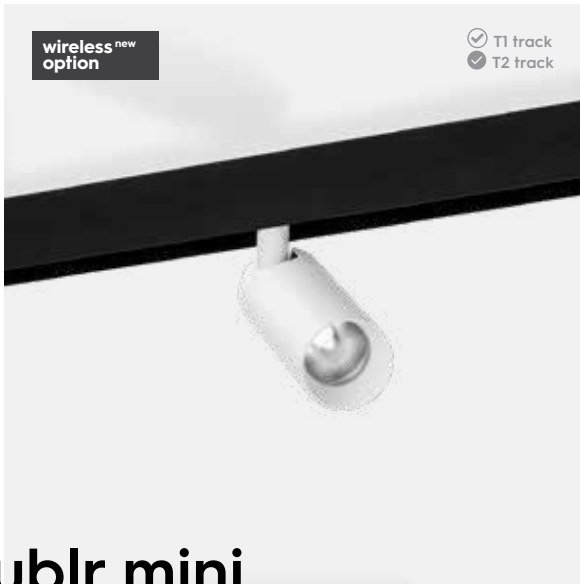

tublr mini 48V track

1x COB LED 600lm 2200K-3000K
48V 6W 600lm 2200K-3000K CRI90+ 40°

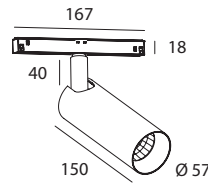

1-10V	1 1 1	FO98031B CL6.40DW
	1 1 2	FO98031-2B CL6.40DW
	1 1 4	FO98031-4B CL6.40DW
	1 1 5	FO98031-5B CL6.40DW
	1 2 2	FO98031-2-2B CL6.40DW
	1 2 1	FO98031-2-1B CL6.40DW
	1 2 4	FO98031-2-4B CL6.40DW
	1 2 5	FO98031-2-5B CL6.40DW
	2 2 2	FO98032B CL6.40DW
	2 2 1	FO98032-1B CL6.40DW
	2 2 4	FO98032-4B CL6.40DW
	2 2 5	FO98032-5B CL6.40DW
	2 1 2	FO98032-1-2B CL6.40DW
	2 1 1	FO98032-1-1B CL6.40DW
	2 1 4	FO98032-1-4B CL6.40DW
	2 1 5	FO98032-1-5B CL6.40DW
	2 7 2	FO98032-7-2B CL6.40DW

HONEYCOMB D50

BS0298

! Wireless dimming available > ref= replace ...D by W
e.g. FO98021B becomes FO97021W

DALI	1 1 1	FO98031D CL6.40DW
	1 1 2	FO98031-2D CL6.40DW
	1 1 4	FO98031-4D CL6.40DW
	1 1 5	FO98031-5D CL6.40DW
	1 2 2	FO98031-2-2D CL6.40DW
	1 2 1	FO98031-2-1D CL6.40DW
	1 2 4	FO98031-2-4D CL6.40DW
	1 2 5	FO98031-2-5D CL6.40DW
	2 2 2	FO98032D CL6.40DW
	2 2 1	FO98032-1D CL6.40DW
	2 2 4	FO98032-4D CL6.40DW
	2 2 5	FO98032-5D CL6.40DW
	2 1 2	FO98032-1-2D CL6.40DW
	2 1 1	FO98032-1-1D CL6.40DW
	2 1 4	FO98032-1-4D CL6.40DW
	2 1 5	FO98032-1-5D CL6.40DW
	2 7 2	FO98032-7-2D CL6.40DW

1 White Structure

2 Black Structure

4 Gold

5 Dark Chrome

7 Champagne

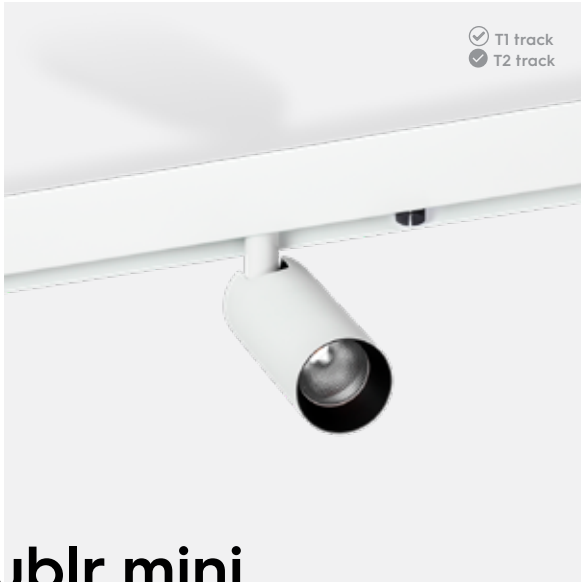

tublr mini

48V track

1x COB LED 1000lm 2700K
48V 10W 1000lm 2700K CRI90+ 24°

replace CLI0_24 for
CLI0_40 40°

WITH DIMMING KNOB	2 2 2	FO98032P CLI0_24WW
	2 2 1	FO98032-1P CLI0_24WW
	2 2 4	FO98032-4P CLI0_24WW
	2 2 5	FO98032-5P CLI0_24WW
	2 1 2	FO98032-1-2P CLI0_24WW
	2 1 1	FO98032-1-1P CLI0_24WW
	2 1 4	FO98032-1-4P CLI0_24WW
	2 1 5	FO98032-1-5P CLI0_24WW
	2 7 2	FO98032-7-2P CLI0_24WW

HONEYCOMB D50 BS0298

replace WW for
NW 3000K
MW 3500K
CW 4000K

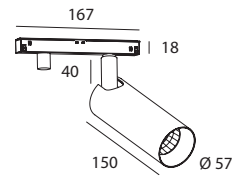

1x COB LED 600lm 2200K-3000K
48V 6W 600lm 2200K-3000K CRI90+ 40°

WITH DIMMING KNOB	2 2 2	FO98032P CL6_40DW
	2 2 1	FO98032-1P CL6_40DW
	2 2 4	FO98032-4P CL6_40DW
	2 2 5	FO98032-5P CL6_40DW
	2 1 2	FO98032-1-2P CL6_40DW
	2 1 1	FO98032-1-1P CL6_40DW
	2 1 4	FO98032-1-4P CL6_40DW
	2 1 5	FO98032-1-5P CL6_40DW
	2 7 2	FO98032-7-2P CL6_40DW

HONEYCOMB D50 BS0298

1	White Structure	5	Dark Chrome
2	Black Structure	7	Champagne
4	Gold		

tublr micro

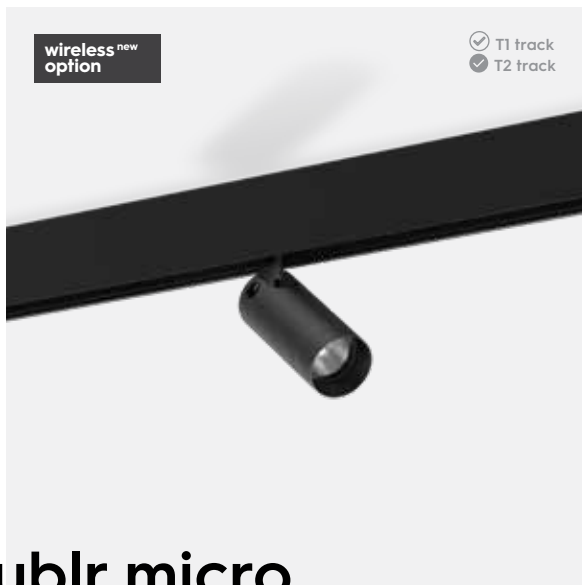

tublr micro

48V track

1x COB LED 1000lm 2700K
48V 10W 1000lm 2700K CRI90+ 24°

replace CLI0_24 for
CLI0_40 40°
CLI0_60 60°

NON-DIM	1 1	FO98501A CLI0_24WW
	1 2	FO98501-2A CLI0_24WW
	2 2	FO98502A CLI0_24WW
	2 1	FO98502-1A CLI0_24WW
1-10V	1 1	FO98501B CLI0_24WW
	1 2	FO98501-2B CLI0_24WW
	2 2	FO98502B CLI0_24WW
	2 1	FO98502-1B CLI0_24WW
DALI	1 1	FO98501D CLI0_24WW
	1 2	FO98501-2D CLI0_24WW
	2 2	FO98502D CLI0_24WW
	2 1	FO98502-1D CLI0_24WW

HONEYCOMB D40

BS0290

replace WW for
NW 3000K
MW 3500K
CW 4000K

! Wireless dimming available > ref= replace ...D by W
e.g. FO98021B becomes FO97021W

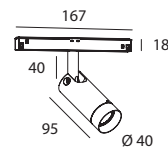

1x COB LED LENS 1000lm 2700K
48V 10W 1000lm 2700K CRI90+ 15°

replace CLI10L15 for
CLI10L24 24°
CLI10L40 40°
CLI10L50 50°

NON-DIM	1 1	FO98501A CLI10L15WW
	1 2	FO98501-2A CLI10L15WW
	2 2	FO98502A CLI10L15WW
	2 1	FO98502-1A CLI10L15WW
1-10V	1 1	FO98501B CLI10L15WW
	1 2	FO98501-2B CLI10L15WW
	2 2	FO98502B CLI10L15WW
	2 1	FO98502-1B CLI10L15WW
DALI	1 1	FO98501D CLI10L15WW
	1 2	FO98501-2D CLI10L15WW
	2 2	FO98502D CLI10L15WW
	2 1	FO98502-1D CLI10L15WW

HONEYCOMB D40

BS0290

replace WW for
NW 3000K
MW 3500K
CW 4000K

1 White Structure
2 Black Anodized



tublr micro

48V track

1x COB LED ZOOM LENS 1000lm 2700K
 48V 10W 1000lm 2700K CRI90+ 20°-36°

NON-DIM	1 1	FO98501A CLI0ZLWW
	1 2	FO98501-2A CLI0ZLWW
	2 2	FO98502A CLI0ZLWW
	2 1	FO98502-1A CLI0ZLWW
1-10V	1 1	FO98501B CLI0ZLWW
	1 2	FO98501-2B CLI0ZLWW
	2 2	FO98502B CLI0ZLWW
	2 1	FO98502-1B CLI0ZLWW
DALI	1 1	FO98501D CLI0ZLWW
	1 2	FO98501-2D CLI0ZLWW
	2 2	FO98502D CLI0ZLWW
	2 1	FO98502-ID CLI0ZLWW

HONEYCOMB D40 BS0290

replace WW for
 NW 3000K
 MW 3500K
 CW 4000K

! ZOOMlens between 20° and 36°
 ! Wireless dimming available > ref= replace ...D by W
 e.g. FO98021B becomes FO97021W

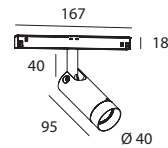

1x COB LED 600lm 2200K-3000K
 48V 6W 600lm 2200K-3000K CRI90+ 40°

replace CL6_40 for
 CL6_60 60°

1-10V	1 1	FO98501B CL6_40DW
	1 2	FO98501-2B CL6_40DW
	2 2	FO98502B CL6_40DW
DALI	2 1	FO98502-1B CL6_40DW
	1 1	FO98501D CL6_40DW
	1 2	FO98501-2D CL6_40DW
DALI	2 2	FO98502D CL6_40DW
	2 1	FO98502-ID CL6_40DW

HONEYCOMB D40 BS0290

1 White Structure
 2 Black Anodized

tubl'r micro

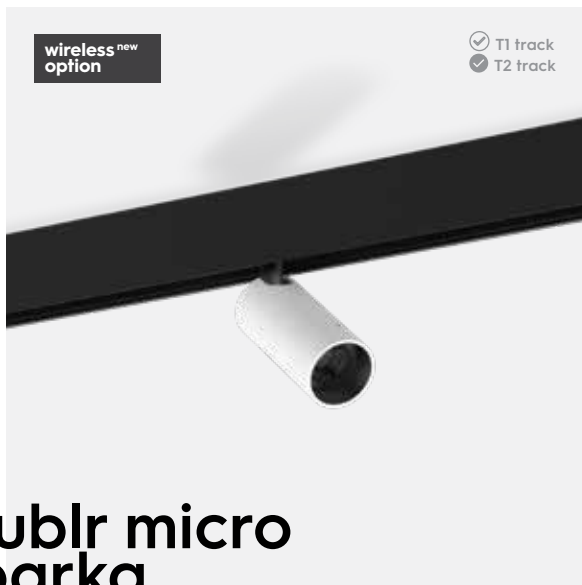

tubl'r micro parka

48V track

1x COB LED 1000lm 2700K
48V 10W 1000lm 2700K CRI90+ 24°

replace CLI0_24 for
CLI0_40 40°
CLI0_60 60°

NON-DIM	1 1 1	FO9851IA CLI0_24WW
	1 1 2	FO9851I-1-2A CLI0_24WW
	1 7 2	FO9851I-7-2A CLI0_24WW
	2 1 2	FO98512-1-2A CLI0_24WW
	2 1 1	FO98512-1-1A CLI0_24WW
	2 7 2	FO98512-7-2A CLI0_24WW

1-10V	1 1 1	FO9851IB CLI0_24WW
	1 1 2	FO9851I-1-2B CLI0_24WW
	1 7 2	FO9851I-7-2B CLI0_24WW
	2 1 2	FO98512-1-2B CLI0_24WW
	2 1 1	FO98512-1-1B CLI0_24WW
	2 7 2	FO98512-7-2B CLI0_24WW

DALI	1 1 1	FO9851ID CLI0_24WW
	1 1 2	FO9851I-1-2D CLI0_24WW
	1 7 2	FO9851I-7-2D CLI0_24WW
	2 1 2	FO98512-1-2D CLI0_24WW
	2 1 1	FO98512-1-1D CLI0_24WW
	2 7 2	FO98512-7-2D CLI0_24WW

HONEYCOMB D40

BS0290

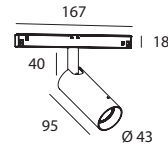

1x COB LED LENS 1000lm 2700K
48V 10W 1000lm 2700K CRI90+ 15°

replace CLI0L15 for
CLI0L24 24°
CLI0L40 40°
CLI0L50 50°

NON-DIM	1 1 1	FO9851IA CLI0L15WW
	1 1 2	FO9851I-1-2A CLI0L15WW
	1 7 2	FO9851I-7-2A CLI0L15WW
	2 1 2	FO98512-1-2A CLI0L15WW
	2 1 1	FO98512-1-1A CLI0L15WW
	2 7 2	FO98512-7-2A CLI0L15WW

1-10V	1 1 1	FO9851IB CLI0L15WW
	1 1 2	FO9851I-1-2B CLI0L15WW
	1 7 2	FO9851I-7-2B CLI0L15WW
	2 1 2	FO98512-1-2B CLI0L15WW
	2 1 1	FO98512-1-1B CLI0L15WW
	2 7 2	FO98512-7-2B CLI0L15WW

DALI	1 1 1	FO9851ID CLI0L15WW
	1 1 2	FO9851I-1-2D CLI0L15WW
	1 7 2	FO9851I-7-2D CLI0L15WW
	2 1 2	FO98512-1-2D CLI0L15WW
	2 1 1	FO98512-1-1D CLI0L15WW
	2 7 2	FO98512-7-2D CLI0L15WW

HONEYCOMB D40

BS0290

replace WW for
NW 3000K
MW 3500K
CW 4000K

! Wireless dimming available > ref= replace ...D by W
e.g. FO98021B becomes FO97021W

- 1 White Structure
- 2 Black Anodized
- 7 Champagne

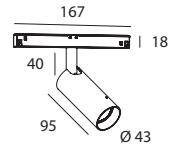

tublr micro parka

48V track

1x COB LED 600lm 2200K-3000K
48V 6W 600lm 2200K-3000K CRI90+ 40°

replace CL6_40 for
CL6_60 60°

1-10V	1	1	1	FO98511B CL6_40DW
	1	1	2	FO98511-1-2B CL6_40DW
	1	7	2	FO98511-7-2B CL6_40DWW
	2	1	2	FO98512-1-2B CL6_40DW
	2	1	1	FO98512-1-1B CL6_40DW
	2	7	2	FO98512-7-2B CL6_40DW

DALI	1	1	1	FO98511D CL6_40DW
	1	1	2	FO98511-1-2D CL6_40DW
	1	7	2	FO98511-7-2D CL6_40DW
	2	1	2	FO98512-1-2D CL6_40DW
	2	1	1	FO98512-1-1D CL6_40DW
	2	7	2	FO98512-7-2D CL6_40DW

HONEYCOMB D40 BS0290

! Wireless dimming available > ref= replace ...D by W
e.g. FO98021B becomes FO97021W

- 1 White Structure
- 2 Black Anodized
- 7 Champagne

tubed suspension



tubed suspension

48V track

1x COB LED 1000lm 2700K
48V 10W 1000lm 2700K CRI90+ 24°

replace CLI0_24 for
CLI0_40 40°

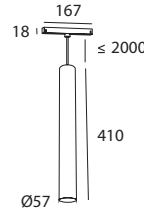

NON-DIM	1 1 1	FO97301A CLI0_24WW
	1 1 2	FO97301-2A CLI0_24WW
	1 1 4	FO97301-4A CLI0_24WW
	1 1 5	FO97301-5A CLI0_24WW
	1 2 2	FO97301-2-2A CLI0_24WW
	1 2 1	FO97301-2-1A CLI0_24WW
	1 2 4	FO97301-2-4A CLI0_24WW
	1 2 5	FO97301-2-5A CLI0_24WW
	2 2 2	FO97302A CLI0_24WW
	2 2 1	FO97302-1A CLI0_24WW
	2 2 4	FO97302-4A CLI0_24WW
	2 2 5	FO97302-5A CLI0_24WW
	2 1 2	FO97302-1-2A CLI0_24WW
	2 1 1	FO97302-1-1A CLI0_24WW
	2 1 4	FO97302-1-4A CLI0_24WW
	2 1 5	FO97302-1-5A CLI0_24WW
	2 7 2	FO97302-7-2A CLI0_24WW

HONEYCOMB D50 BS0298

! Wireless dimming available > ref= replace ...D by W
e.g. FO9702ID becomes FO9702IW

1-10V	1 1 1	FO97301B CLI0_24WW
	1 1 2	FO97301-2B CLI0_24WW
	1 1 4	FO97301-4B CLI0_24WW
	1 1 5	FO97301-5B CLI0_24WW
	1 2 2	FO97301-2-2B CLI0_24WW
	1 2 1	FO97301-2-1B CLI0_24WW
	1 2 4	FO97301-2-4B CLI0_24WW
	1 2 5	FO97301-2-5B CLI0_24WW
	2 2 2	FO97302B CLI0_24WW
	2 2 1	FO97302-1B CLI0_24WW
	2 2 4	FO97302-4B CLI0_24WW
	2 2 5	FO97302-5B CLI0_24WW
	2 1 2	FO97302-1-2B CLI0_24WW
	2 1 1	FO97302-1-1B CLI0_24WW
2 1 4	FO97302-1-4B CLI0_24WW	
2 1 5	FO97302-1-5B CLI0_24WW	
2 7 2	FO97302-7-2B CLI0_24WW	

DALI	1 1 1	FO97301D CLI0_24WW
	1 1 2	FO97301-2D CLI0_24WW
	1 1 4	FO97301-4D CLI0_24WW
	1 1 5	FO97301-5D CLI0_24WW
	1 2 2	FO97301-2-2D CLI0_24WW
	1 2 1	FO97301-2-1D CLI0_24WW
	1 2 4	FO97301-2-4D CLI0_24WW
	1 2 5	FO97301-2-5D CLI0_24WW
	2 2 2	FO97302D CLI0_24WW
	2 2 1	FO97302-1D CLI0_24WW
	2 2 4	FO97302-4D CLI0_24WW
	2 2 5	FO97302-5D CLI0_24WW
	2 1 2	FO97302-1-2D CLI0_24WW
	2 1 1	FO97302-1-1D CLI0_24WW
2 1 4	FO97302-1-4D CLI0_24WW	
2 1 5	FO97302-1-5D CLI0_24WW	
2 7 2	FO97302-7-2D CLI0_24WW	

replace WW for
NW 3000K
MW 3500K
CW 4000K

- 1 White Structure
- 2 Black Structure
- 4 Gold
- 5 Dark Chrome
- 7 Champagne

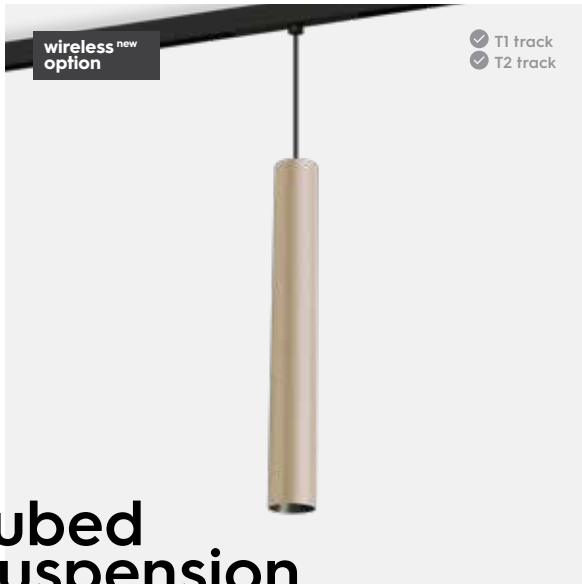

tubed suspension

48V track

1x COB LED 600lm 2200K-3000K
48V 6W 600lm 2200K-3000K CRI90+ 40°

1-10V	1 1 1	FO97301B CL6_40DW
	1 1 2	FO97301-2B CL6_40DW
	1 1 4	FO97301-4B CL6_40DW
	1 1 5	FO97301-5B CL6_40DW
	1 2 2	FO97301-2-2B CL6_40DW
	1 2 1	FO97301-2-1B CL6_40DW
	1 2 4	FO97301-2-4B CL6_40DW
	1 2 5	FO97301-2-5B CL6_40DW
	2 2 2	FO97302B CL6_40DW
	2 2 1	FO97302-1B CL6_40DW
	2 2 4	FO97302-4B CL6_40DW
	2 2 5	FO97302-5B CL6_40DW
	2 1 2	FO97302-1-2B CL6_40DW
	2 1 1	FO97302-1-1B CL6_40DW
	2 1 4	FO97302-1-4B CL6_40DW
	2 1 5	FO97302-1-5B CL6_40DW
	2 7 2	FO97302-7-2B CL6_40DW

HONEYCOMB D50

BS0298

! Wireless dimming available > ref= replace ...D by W
e.g. FO98021B becomes FO97021W

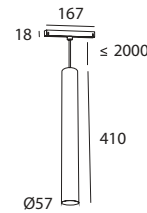

DALI	1 1 1	FO97301D CL6_40DW
	1 1 2	FO97301-2D CL6_40DW
	1 1 4	FO97301-4D CL6_40DW
	1 1 5	FO97301-5D CL6_40DW
	1 2 2	FO97301-2-2D CL6_40DW
	1 2 1	FO97301-2-1D CL6_40DW
	1 2 4	FO97301-2-4D CL6_40DW
	1 2 5	FO97301-2-5D CL6_40DW
	2 2 2	FO97302D CL6_40DW
	2 2 1	FO97302-1D CL6_40DW
	2 2 4	FO97302-4D CL6_40DW
	2 2 5	FO97302-5D CL6_40DW
	2 1 2	FO97302-1-2D CL6_40DW
	2 1 1	FO97302-1-1D CL6_40DW
	2 1 4	FO97302-1-4D CL6_40DW
	2 1 5	FO97302-1-5D CL6_40DW
	2 7 2	FO97302-7-2D CL6_40DW

1 White Structure

2 Black Structure

4 Gold

5 Dark Chrome

7 Champagne

tubed suspension

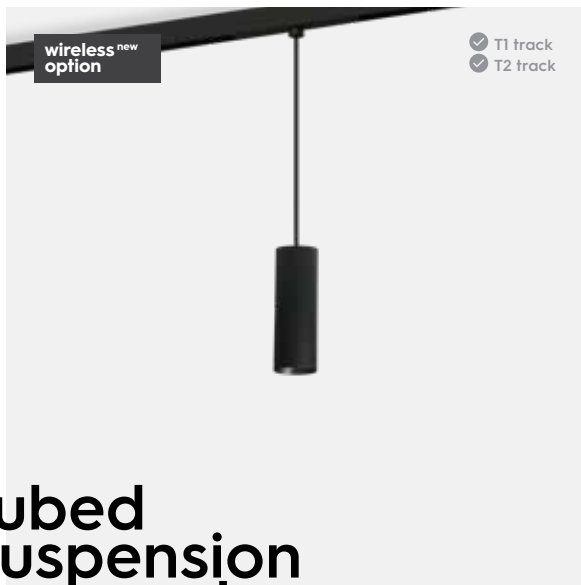

tubed suspension compact 48V track

1x COB LED 1000lm 2700K
48V 10W 1000lm 2700K CRI90+ 24°

replace CLI0_24 for
CLI0_40 40°

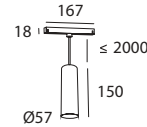

NON-DIM	Structure	Product Code
1 1 1	White Structure	FO97311A CLI0_24WW
1 1 2	Black Structure	FO97311-2A CLI0_24WW
1 1 4	Gold	FO97311-4A CLI0_24WW
1 1 5	Dark Chrome	FO97311-5A CLI0_24WW
1 2 2	Black Structure	FO97311-2-2A CLI0_24WW
1 2 1	Black Structure	FO97311-2-1A CLI0_24WW
1 2 4	Gold	FO97311-2-4A CLI0_24WW
1 2 5	Dark Chrome	FO97311-2-5A CLI0_24WW
2 2 2	Black Structure	FO97312A CLI0_24WW
2 2 1	Black Structure	FO97312-1A CLI0_24WW
2 2 4	Gold	FO97312-4A CLI0_24WW
2 2 5	Dark Chrome	FO97312-5A CLI0_24WW
2 1 2	Black Structure	FO97312-1-2A CLI0_24WW
2 1 1	Black Structure	FO97312-1-1A CLI0_24WW
2 1 4	Gold	FO97312-1-4A CLI0_24WW
2 1 5	Dark Chrome	FO97312-1-5A CLI0_24WW
2 7 2	Champagne	FO97312-7-2A CLI0_24WW

HONEYCOMB D50

BS0298

! Wireless dimming available > ref= replace ...D by W
e.g. FO97021D becomes FO97021W

1-10V	Structure	Product Code
1 1 1	White Structure	FO97311B CLI0_24WW
1 1 2	Black Structure	FO97311-2B CLI0_24WW
1 1 4	Gold	FO97311-4B CLI0_24WW
1 1 5	Dark Chrome	FO97311-5B CLI0_24WW
1 2 2	Black Structure	FO97311-2-2B CLI0_24WW
1 2 1	Black Structure	FO97311-2-1B CLI0_24WW
1 2 4	Gold	FO97311-2-4B CLI0_24WW
1 2 5	Dark Chrome	FO97311-2-5B CLI0_24WW
2 2 2	Black Structure	FO97312B CLI0_24WW
2 2 1	Black Structure	FO97312-1B CLI0_24WW
2 2 4	Gold	FO97312-4B CLI0_24WW
2 2 5	Dark Chrome	FO97312-5B CLI0_24WW
2 1 2	Black Structure	FO97312-1-2B CLI0_24WW
2 1 1	Black Structure	FO97312-1-1B CLI0_24WW
2 1 4	Gold	FO97312-1-4B CLI0_24WW
2 1 5	Dark Chrome	FO97312-1-5B CLI0_24WW
2 7 2	Champagne	FO97312-7-2B CLI0_24WW

DALI	Structure	Product Code
1 1 1	White Structure	FO97311D CLI0_24WW
1 1 2	Black Structure	FO97311-2D CLI0_24WW
1 1 4	Gold	FO97311-4D CLI0_24WW
1 1 5	Dark Chrome	FO97311-5D CLI0_24WW
1 2 2	Black Structure	FO97311-2-2D CLI0_24WW
1 2 1	Black Structure	FO97311-2-1D CLI0_24WW
1 2 4	Gold	FO97311-2-4D CLI0_24WW
1 2 5	Dark Chrome	FO97311-2-5D CLI0_24WW
2 2 2	Black Structure	FO97312D CLI0_24WW
2 2 1	Black Structure	FO97312-1D CLI0_24WW
2 2 4	Gold	FO97312-4D CLI0_24WW
2 2 5	Dark Chrome	FO97312-5D CLI0_24WW
2 1 2	Black Structure	FO97312-1-2D CLI0_24WW
2 1 1	Black Structure	FO97312-1-1D CLI0_24WW
2 1 4	Gold	FO97312-1-4D CLI0_24WW
2 1 5	Dark Chrome	FO97312-1-5D CLI0_24WW
2 7 2	Champagne	FO97312-7-2D CLI0_24WW

replace WW for
NW 3000K
MW 3500K
CW 4000K

1 White Structure
2 Black Structure
4 Gold

5 Dark Chrome
7 Champagne



tubed suspension compact 48V track

1x COB LED 600lm 2200K-3000K
48V 6W 600lm 2200K-3000K CRI90+ 40°

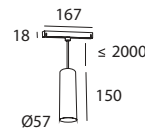

1-10V	1 1 1	FO97311B CL6_40DW
	1 1 2	FO97311-2B CL6_40DW
	1 1 4	FO97311-4B CL6_40DW
	1 1 5	FO97311-5B CL6_40DW
	1 2 2	FO97311-2-2B CL6_40DW
	1 2 1	FO97311-2-1B CL6_40DW
	1 2 4	FO97311-2-4B CL6_40DW
	1 2 5	FO97311-2-5B CL6_40DW
	2 2 2	FO97312B CL6_40DW
	2 2 1	FO97312-1B CL6_40DW
	2 2 4	FO97312-4B CL6_40DW
	2 2 5	FO97312-5B CL6_40DW
	2 1 2	FO97312-1-2B CL6_40DW
	2 1 1	FO97312-1-1B CL6_40DW
	2 1 4	FO97312-1-4B CL6_40DW
	2 1 5	FO97312-1-5B CL6_40DW
2 7 2	FO97312-7-2B CL6_40DW	

HONEYCOMB D50

BS0298

! Wireless dimming available > ref= replace ...D by W
e.g. FO98021B becomes FO97021W

DALI	1 1 1	FO97311D CL6_40DW
	1 1 2	FO97311-2D CL6_40DW
	1 1 4	FO97311-4D CL6_40DW
	1 1 5	FO97311-5D CL6_40DW
	1 2 2	FO97311-2-2D CL6_40DW
	1 2 1	FO97311-2-1D CL6_40DW
	1 2 4	FO97311-2-4D CL6_40DW
	1 2 5	FO97311-2-5D CL6_40DW
	2 2 2	FO97312D CL6_40DW
	2 2 1	FO97312-1D CL6_40DW
	2 2 4	FO97312-4D CL6_40DW
	2 2 5	FO97312-5D CL6_40DW
	2 1 2	FO97312-1-2D CL6_40DW
	2 1 1	FO97312-1-1D CL6_40DW
	2 1 4	FO97312-1-4D CL6_40DW
	2 1 5	FO97312-1-5D CL6_40DW
2 7 2	FO97312-7-2D CL6_40DW	

1 White Structure

2 Black Structure

4 Gold

5 Dark Chrome

7 Champagne

tubed micro suspension

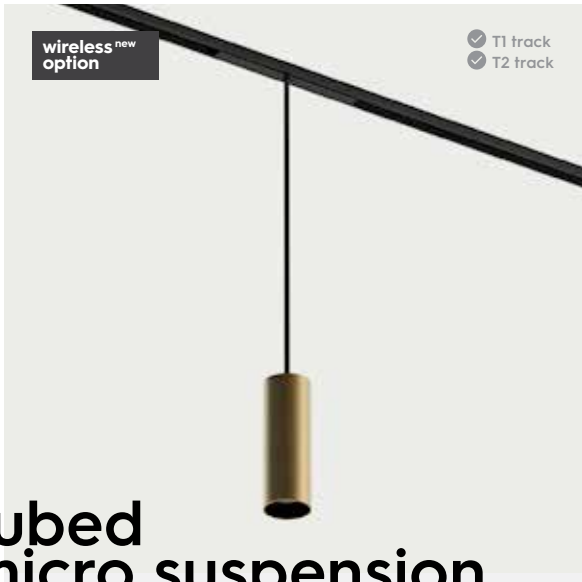

tubed micro suspension

48V track

1x COB LED 1000lm 2700K
48V 10W 1000lm 2700K CRI90+ 24°

replace CLI0_24 for
CLI0_40 40°
CLI0_60 60°

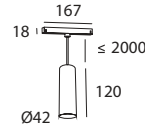

NON-DIM	1 1 1	FO97321A CLI0_24WW
	1 1 2	FO97321-2A CLI0_24WW
	1 1 4	FO97321-4A CLI0_24WW
	1 1 5	FO97321-5A CLI0_24WW
	1 2 2	FO97321-2-2A CLI0_24WW
	1 2 1	FO97321-2-1A CLI0_24WW
	1 2 4	FO97321-2-4A CLI0_24WW
	1 2 5	FO97321-2-5A CLI0_24WW
	2 2 2	FO97322A CLI0_24WW
	2 2 1	FO97322-1A CLI0_24WW
	2 2 4	FO97322-4A CLI0_24WW
	2 2 5	FO97322-5A CLI0_24WW
	2 1 2	FO97322-1-2A CLI0_24WW
	2 1 1	FO97322-1-1A CLI0_24WW
	2 1 4	FO97322-1-4A CLI0_24WW
	2 1 5	FO97322-1-5A CLI0_24WW
	2 7 2	FO97322-7-2A CLI0_24WW

HONEYCOMB D50 BS0298

! Wireless dimming available > ref= replace ...D by W
e.g. FO97021D becomes FO97021W

I-10V	1 1 1	FO97321B CLI0_24WW
	1 1 2	FO97321-2B CLI0_24WW
	1 1 4	FO97321-4B CLI0_24WW
	1 1 5	FO97321-5B CLI0_24WW
	1 2 2	FO97321-2-2B CLI0_24WW
	1 2 1	FO97321-2-1B CLI0_24WW
	1 2 4	FO97321-2-4B CLI0_24WW
	1 2 5	FO97321-2-5B CLI0_24WW
	2 2 2	FO97322B CLI0_24WW
	2 2 1	FO97322-1B CLI0_24WW
	2 2 4	FO97322-4B CLI0_24WW
	2 2 5	FO97322-5B CLI0_24WW
	2 1 2	FO97322-1-2B CLI0_24WW
	2 1 1	FO97322-1-1B CLI0_24WW
	2 1 4	FO97322-1-4B CLI0_24WW
2 1 5	FO97322-1-5B CLI0_24WW	
2 7 2	FO97322-7-2B CLI0_24WW	

DALI	1 1 1	FO97321D CLI0_24WW
	1 1 2	FO97321-2D CLI0_24WW
	1 1 4	FO97321-4D CLI0_24WW
	1 1 5	FO97321-5D CLI0_24WW
	1 2 2	FO97321-2-2D CLI0_24WW
	1 2 1	FO97321-2-1D CLI0_24WW
	1 2 4	FO97321-2-4D CLI0_24WW
	1 2 5	FO97321-2-5D CLI0_24WW
	2 2 2	FO97322D CLI0_24WW
	2 2 1	FO97322-1D CLI0_24WW
	2 2 4	FO97322-4D CLI0_24WW
	2 2 5	FO97322-5D CLI0_24WW
	2 1 2	FO97322-1-2D CLI0_24WW
	2 1 1	FO97322-1-1D CLI0_24WW
	2 1 4	FO97322-1-4D CLI0_24WW
2 1 5	FO97322-1-5D CLI0_24WW	
2 7 2	FO97322-7-2D CLI0_24WW	

replace WW for
NW 3000K
MW 3500K
CW 4000K

- 1 White Structure
- 2 Black Structure
- 4 Gold
- 5 Dark Chrome
- 7 Champagne

wireless^{new}
option

- ✓ T1 track
- ✓ T2 track

tubed micro suspension

48V track

1x COB LED LENS 1000lm 2700K
48V 10W 1000lm 2700K CRI90+ 15°

replace CLI0L15 for
 CLI0L24 24°
 CLI0L40 40°
 CLI0L50 50°

NON-DIM	1 1 1	FO97321A CLI0L15WW
	1 1 2	FO97321-2A CLI0L15WW
	1 1 4	FO97321-4A CLI0L15WW
	1 1 5	FO97321-5A CLI0L15WW
	1 2 2	FO97321-2-2A CLI0L15WW
	1 2 1	FO97321-2-1A CLI0L15WW
	1 2 4	FO97321-2-4A CLI0L15WW
	1 2 5	FO97321-2-5A CLI0L15WW
	2 2 2	FO97322A CLI0L15WW
	2 2 1	FO97322-1A CLI0L15WW
	2 2 4	FO97322-4A CLI0L15WW
	2 2 5	FO97322-5A CLI0L15WW
	2 1 2	FO97322-1-2A CLI0L15WW
	2 1 1	FO97322-1-1A CLI0L15WW
	2 1 4	FO97322-1-4A CLI0L15WW
	2 1 5	FO97322-1-5A CLI0L15WW
	2 7 2	FO97322-7-2A CLI0L15WW

HONEYCOMB D50

BS0298

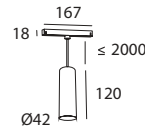

1-10V

1 1 1	FO97321B CLI0L15WW
1 1 2	FO97321-2B CLI0L15WW
1 1 4	FO97321-4B CLI0L15WW
1 1 5	FO97321-5B CLI0L15WW
1 2 2	FO97321-2-2B CLI0L15WW
1 2 1	FO97321-2-1B CLI0L15WW
1 2 4	FO97321-2-4B CLI0L15WW
1 2 5	FO97321-2-5B CLI0L15WW
2 2 2	FO97322B CLI0L15WW
2 2 1	FO97322-1B CLI0L15WW
2 2 4	FO97322-4B CLI0L15WW
2 2 5	FO97322-5B CLI0L15WW
2 1 2	FO97322-1-2B CLI0L15WW
2 1 1	FO97322-1-1B CLI0L15WW
2 1 4	FO97322-1-4B CLI0L15WW
2 1 5	FO97322-1-5B CLI0L15WW
2 7 2	FO97322-7-2B CLI0L15WW

DALI

1 1 1	FO97321D CLI0L15WW
1 1 2	FO97321-2D CLI0L15WW
1 1 4	FO97321-4D CLI0L15WW
1 1 5	FO97321-5D CLI0L15WW
1 2 2	FO97321-2-2D CLI0L15WW
1 2 1	FO97321-2-1D CLI0L15WW
1 2 4	FO97321-2-4D CLI0L15WW
1 2 5	FO97321-2-5D CLI0L15WW
2 2 2	FO97322D CLI0L15WW
2 2 1	FO97322-1D CLI0L15WW
2 2 4	FO97322-4D CLI0L15WW
2 2 5	FO97322-5D CLI0L15WW
2 1 2	FO97322-1-2D CLI0L15WW
2 1 1	FO97322-1-1D CLI0L15WW
2 1 4	FO97322-1-4D CLI0L15WW
2 1 5	FO97322-1-5D CLI0L15WW
2 7 2	FO97322-7-2D CLI0L15WW

replace WW for
 NW 3000K
 MW 3500K
 CW 4000K

! Wireless dimming available > ref= replace ...D by W
 e.g. FO97021D becomes FO97021W

- 1 White Structure
- 2 Black Structure
- 4 Gold
- 5 Dark Chrome
- 7 Champagne

traxx twist

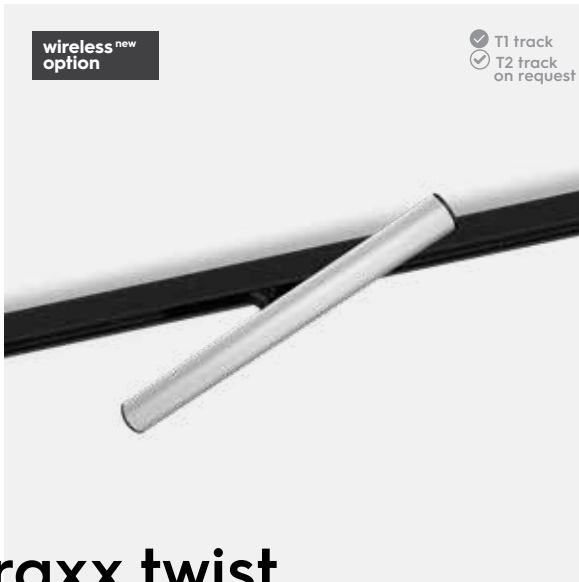

traxx twist

48V track

1x LEDLINE 710lm 3000K
48V 6,1 W 710lm 3000K CRI90+

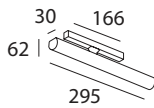

DALI

2

FO97432D LL7NW

1x LEDLINE 1420lm 3000K
48V 11.4W 1420lm 3000K CRI90+

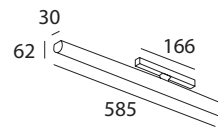

DALI

2

FO97442D LLI4NW

replace NW for
CW 4000K

! Wireless dimming COMING SOON > ref= replace ...D by W
e.g. FO97322-1-ID becomes FO97322-1-IW

traxx mini

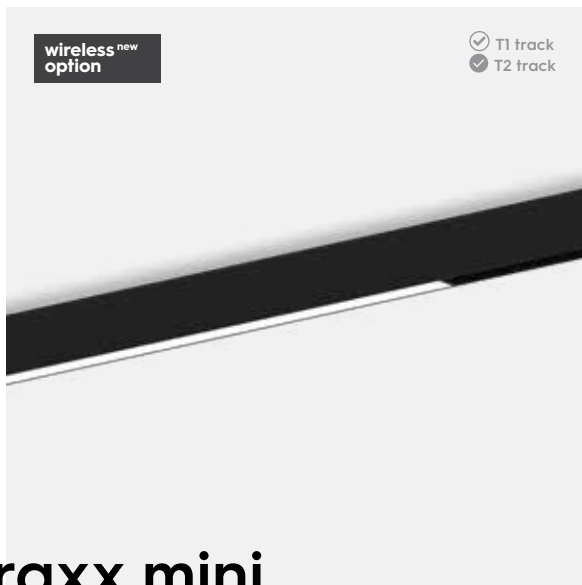

traxx mini 48V track

1x LEDLINE 600lm 2700K
48V 6W 700lm 2700K CRI90+ 60°

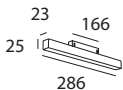

N-D 1 FO97301A LL7_60WW
2 FO97302A LL7_60WW

I-10V NOT AVAILABLE

DALI 1 FO97301D LL7_60WW
2 FO97302D LL7_60WW

replace WW for
NW 3000K
CW 4000K

! Wireless dimming available > ref= replace ...D by W
e.g. FO9802IB becomes FO9702IW

1x LEDLINE 1500lm 2700K
48V 12W 1500lm 2700K CRI90+ 60°

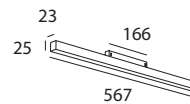

N-D 1 FO97311A LL15_60WW
2 FO97312A LL15_60WW

I-10V NOT AVAILABLE

DALI 1 FO97311D LL15_60WW
2 FO97312D LL15_60WW

replace WW for
NW 3000K
CW 4000K

1x LEDLINE 2200lm 2700K
48V 18W 2200lm 2700K CRI90+ 60°

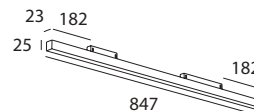

N-D 1 FO97321A LL22_60WW
2 FO97322A LL22_60WW

I-10V 1 FO97321B LL22_60WW
2 FO97322B LL22_60WW

DALI 1 FO97321D LL22_60WW
2 FO97322D LL22_60WW

replace WW for
NW 3000K
CW 4000K

! Wireless dimming available > ref= replace ...D by W
e.g. FO9802IB becomes FO9702IW

1 White Structure
2 Black Structure

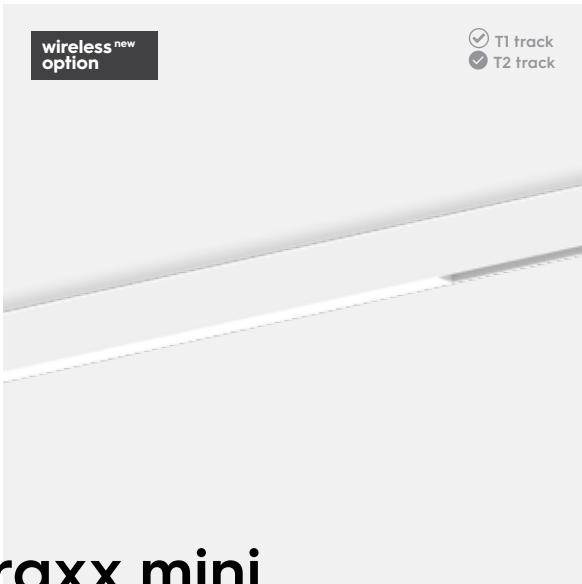

traxx mini

48V track

1x LEDLINE 3000lm 2700K
48V 24W 3000lm 2700K CRI90+ 60°

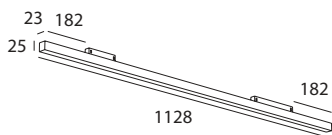

N-D	1	FO97331A LL30_60WW
	2	FO97332A LL30_60WW
I-10V	1	FO97331B LL30_60WW
	2	FO97332B LL30_60WW
DALI	1	FO97331D LL30_60WW
	2	FO97332D LL30_60WW

replace WW for
NW 3000K
CW 4000K

! Wireless dimming available > ref= replace ...D by W
e.g. FO98021B becomes FO97021W

1x LEDLINE 3600lm 2700K
48V 30W 1000lm 3600K CRI90+ 60°

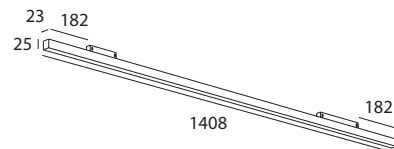

N-D	1	FO97341A LL36_60WW
	2	FO97342A LL36_60WW
I-10V		NOT AVAILABLE
DALI	1	FO97341D LL36_60WW
	2	FO97342D LL36_60WW

replace WW for
NW 3000K
CW 4000K

! Wireless dimming available > ref= replace ...D by W
e.g. FO98021B becomes FO97021W

- 1 White Structure
- 2 Black Structure

traxx rithm

ugr < 19

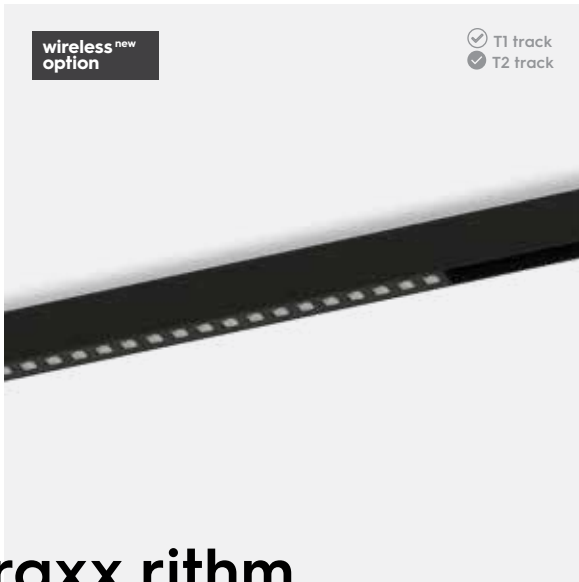

traxx rithm 48V track

1x LEDLINE 600lm 2700K
48V 6W 600lm 2700K CRI90+ 45°

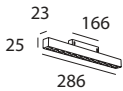

N-D	1	FO97101A LL6_45WW
	2	FO97102A LL6_45WW
I-10V	1	FO97101B LL6_45WW
	2	FO97102B LL6_45WW
DALI	1	FO97101D LL6_45WW
	2	FO97102D LL6_45WW

replace WW for
NW 3000K
CW 4000K

! Wireless dimming available > ref= replace ...D by W
e.g. FO98021B becomes FO97021W

1x LEDLINE 1100lm 2700K
48V 10W 1100lm 2700K CRI90+ 45°

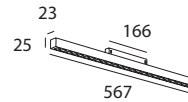

N-D	1	FO97111A LL11_45WW
	2	FO97112A LL11_45WW
I-10V	1	FO97111B LL11_45WW
	2	FO97112B LL11_45WW
DALI	1	FO97111D LL11_45WW
	2	FO97112D LL11_45WW

replace WW for
NW 3000K
CW 4000K

! Wireless dimming available > ref= replace ...D by W
e.g. FO98021B becomes FO97021W

- 1 White Structure
- 2 Black Structure

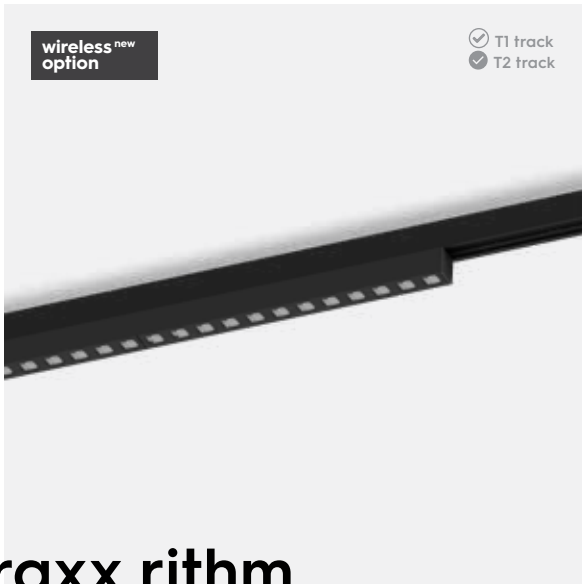

traxx rithm

48V track

1x LEDLINE 1700lm 2700K
48V 15W 1700lm 2700K CRI90+ 45°

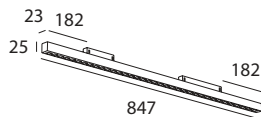

N-D	1	FO97121A LL17_45WW
	2	FO97122A LL17_45WW

I-10V		NOT AVAILABLE
-------	--	---------------

DALI	1	FO97121D LL17_45WW
	2	FO97122D LL17_45WW

replace WW for
NW 3000K
CW 4000K

! Wireless dimming available > ref= replace ...D by W
e.g. FO98021B becomes FO97021W

1x LEDLINE 2100lm 2700K
48V 18W 2100lm 2700K CRI90+ 45°

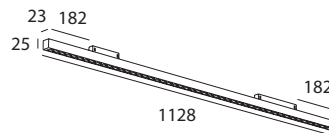

N-D	1	FO97131A LL21_45WW
	2	FO97132A LL21_45WW

I-10V		NOT AVAILABLE
-------	--	---------------

DALI	1	FO97131D LL21_45WW
	2	FO97132D LL21_45WW

replace WW for
NW 3000K
CW 4000K

! Wireless dimming available > ref= replace ...D by W
e.g. FO98021B becomes FO97021W

- 1 White Structure
- 2 Black Structure

traxx rithm

lens

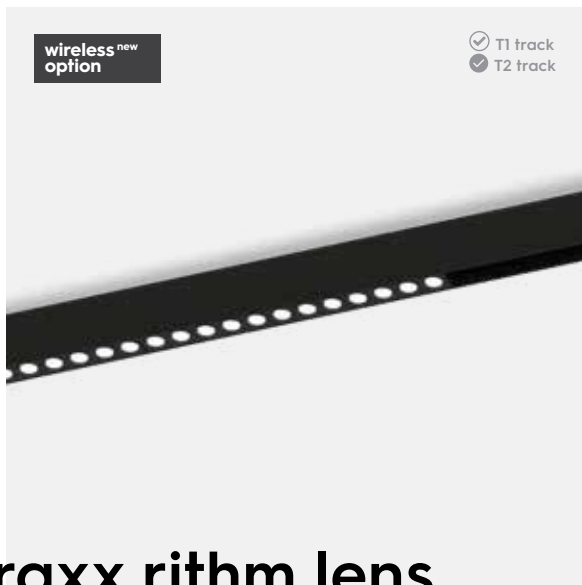

traxx rithm lens

48V track

1x LEDLINE 600lm 2700K
48V 5W 600lm 2700K CRI90+

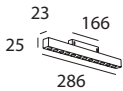

NON-DIM	1	20°	FO97141A LL6_20WW
	2	20°	FO97142A LL6_20WW
	1	30°	FO97141A LL6_30WW
	2	30°	FO97142A LL6_30WW
1-10V	1	20°	FO97141B LL6_20WW
	2	20°	FO97142B LL6_20WW
	1	30°	FO97141B LL6_30WW
	2	30°	FO97142B LL6_30WW
DALI	1	20°	FO97141D LL6_20WW
	2	20°	FO97142D LL6_20WW
	1	30°	FO97141D LL6_30WW
	2	30°	FO97142D LL6_30WW

replace WW for
NW 3000K
CW 4000K

1x LEDLINE 1100lm 2700K
48V 10W 1100lm 2700K CRI90+

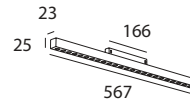

NON-DIM	1	20°	FO97151A LL11_20WW
	2	20°	FO97152A LL11_20WW
	1	30°	FO97151A LL11_30WW
	2	30°	FO97152A LL11_30WW
1-10V	1	20°	FO97151B LL11_20WW
	2	20°	FO97152B LL11_20WW
	1	30°	FO97151B LL11_30WW
	2	30°	FO97152B LL11_30WW
DALI	1	20°	FO97151D LL11_20WW
	2	20°	FO97152D LL11_20WW
	1	30°	FO97151D LL11_30WW
	2	30°	FO97152D LL11_30WW

replace WW for
NW 3000K
CW 4000K

! Wireless dimming available > ref= replace ...D by W
e.g. FO98021B becomes FO97021W

1 White Structure
2 Black Structure

1x LEDLINE 1700lm 2700K
48V 14W 1700lm 2700K CRI90+

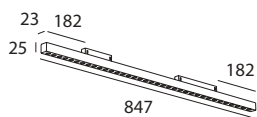

NON-DIM	1	20°	FO9716IA LL17_20WW
	2	20°	FO97162A LL17_20WW
	1	30°	FO9716IA LL17_30WW
	2	30°	FO97162A LL17_30WW
I-10V	NOT AVAILABLE		
DALI	1	20°	FO9716ID LL17_20WW
	2	20°	FO97162D LL17_20WW
	1	30°	FO9716ID LL17_30WW
	2	30°	FO97162D LL17_30WW

replace WW for
NW 3000K
CW 4000K

! Wireless dimming available > ref= replace ...D by W
e.g. FO98021B becomes FO97021W

1x LEDLINE 2100lm 2700K
48V 18W 2100lm 2700K CRI90+

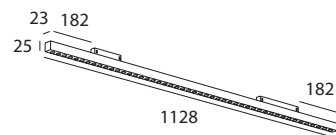

NON-DIM	1	20°	FO97171A LL21_20WW
	2	20°	FO97172A LL21_20WW
	1	30°	FO97171A LL21_30WW
	2	30°	FO97172A LL21_30WW
I-10V	NOT AVAILABLE		
DALI	1	20°	FO97171D LL21_20WW
	2	20°	FO97172D LL21_20WW
	1	30°	FO97171D LL21_30WW
	2	30°	FO97172D LL21_30WW

replace WW for
NW 3000K
CW 4000K

1 White Structure
2 Black Structure

traxx mini tilt



traxx mini tilt 48V track

1x LEDLINE 600lm 2700K
48V 6W 600lm 2700K CRI90+ 60°

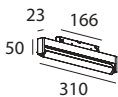

N-D	1	FO97401A LL7_60WW
	2	FO97402A LL7_60WW
I-10V		NOT AVAILABLE
DALI	1	FO97401D LL7_60WW
	2	FO97402D LL7_60WW

replace WW for
NW 3000K
CW 4000K

! Wireless dimming available > ref= replace ...D by W
e.g. FO9802IB becomes FO9702IW

1x LEDLINE 1500lm 2700K
48V 12W 1500lm 2700K CRI90+ 60°

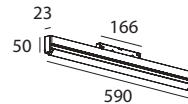

N-D	1	FO97411A LL15_60WW
	2	FO97412A LL15_60WW
I-10V		NOT AVAILABLE
DALI	1	FO97411D LL15_60WW
	2	FO97412D LL15_60WW

replace WW for
NW 3000K
CW 4000K

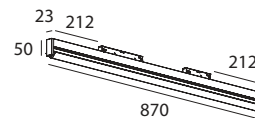

1x LEDLINE 2200lm 2700K
48V 18W 2200lm 2700K CRI90+ 60°

N-D	1	FO97421A LL22_60WW
	2	FO97422A LL22_60WW
I-10V	1	FO97421B LL22_60WW
	2	FO97422B LL22_60WW
DALI	1	FO97421D LL22_60WW
	2	FO97422D LL22_60WW

! Wireless dimming available > ref= replace ...D by W
e.g. FO9802IB becomes FO9702IW

replace WW for
NW 3000K
CW 4000K

- 1 White Structure
- 2 Black Structure

traxx rithm tilt

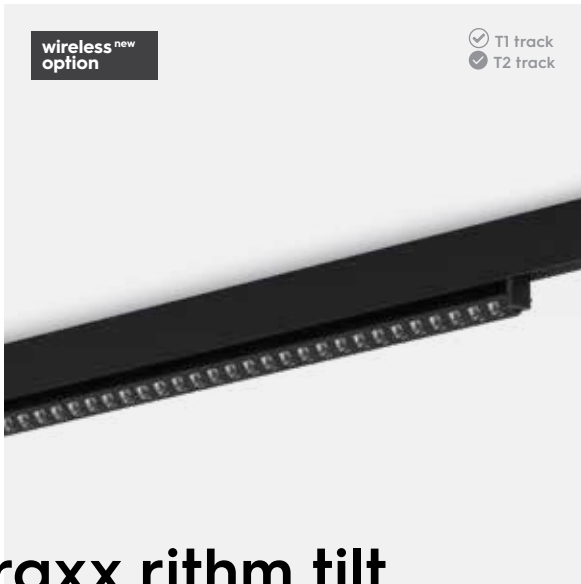

traxx rithm tilt 48V track

1x LEDLINE 600lm 2700K
48V 6W 600lm 2700K CRI90+ 45°

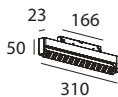

N-D	1	FO97301A LL7_60WW
	2	FO97302A LL7_60WW
1-10V	1	FO97301B LL7_60WW
	2	FO97302B LL7_60WW
DALI	1	FO97301D LL7_60WW
	2	FO97302D LL7_60WW

replace WW for
NW 3000K
CW 4000K

! Wireless dimming available > ref= replace ...D by W
e.g. FO98021B becomes FO97021W

1x LEDLINE 1100lm 2700K
48V 10W 1100lm 2700K CRI90+ 45°

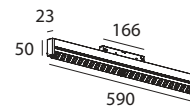

N-D	1	FO97311A LL15_60WW
	2	FO97312A LL15_60WW
1-10V	1	FO97311B LL15_60WW
	2	FO97312B LL15_60WW
DALI	1	FO97311D LL15_60WW
	2	FO97312D LL15_60WW

replace WW for
NW 3000K
CW 4000K

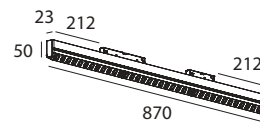

1x LEDLINE 1700lm 2700K
48V 15W 1700lm 2700K CRI90+ 45°

N-D	1	FO97221A LL17_45WW
	2	FO97222A LL17_45WW
1-10V		NOT AVAILABLE
DALI	1	FO97221D LL17_45WW
	2	FO97222D LL17_45WW

! Wireless dimming available > ref= replace ...D by W
e.g. FO98021B becomes FO97021W

replace WW for
NW 3000K
CW 4000K

- 1 White Structure
- 2 Black Structure

traxx rithm tilt lens

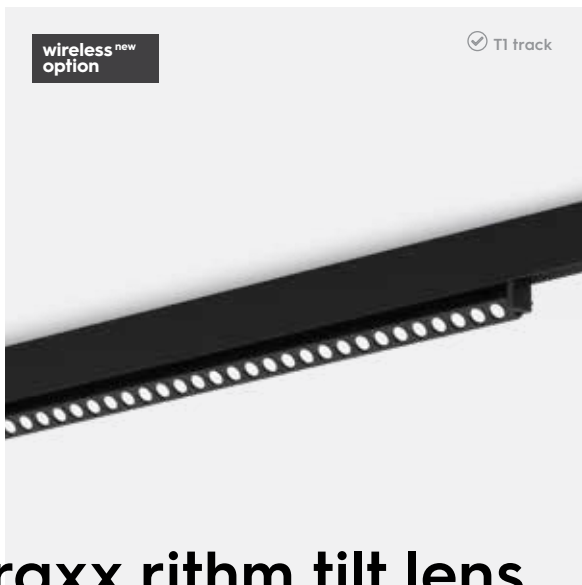

traxx rithm tilt lens

48V track

1x LEDLINE 600lm 2700K
48V 5W 600lm 2700K CRI90+

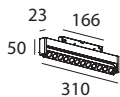

NON-DIM	2	20°	FO97242A LL6_20WW
	2	30°	FO97242A LL6_30WW
1-10V	2	20°	FO97242B LL6_20WW
	2	30°	FO97242B LL6_30WW
DALI	2	20°	FO97242D LL6_20WW
	2	30°	FO97242D LL6_30WW

replace WW for
NW 3000K
CW 4000K

! Wireless dimming available > ref= replace ...D by W
e.g. FO98021B becomes FO97021W

1x LEDLINE 1100lm 2700K
48V 10W 1100lm 2700K CRI90+

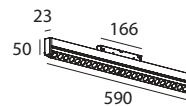

NON-DIM	1	20°	FO97251A LL11_20WW
	2	20°	FO97252A LL11_20WW
NON-DIM	1	30°	FO97251A LL11_30WW
	2	30°	FO97252A LL11_30WW
1-10V	1	20°	FO97251B LL11_20WW
	2	20°	FO97252B LL11_20WW
1-10V	1	30°	FO97251B LL11_30WW
	2	30°	FO97252B LL11_30WW
DALI	1	20°	FO97251D LL11_20WW
	2	20°	FO97252D LL11_20WW
DALI	1	30°	FO97251D LL11_30WW
	2	30°	FO97252D LL11_30WW

replace WW for
NW 3000K
CW 4000K

1 White Structure
2 Black Structure

1x LEDLINE 1700lm 2700K
 48V 14W 1700lm 2700K CRI90+

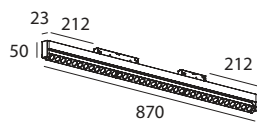

NON-DIM	1	20°	FO97261A LLI7_20WW
	2	20°	FO97262A LLI7_20WW
	1	30°	FO97261A LLI7_30WW
	2	30°	FO97262A LLI7_30WW
I-10V	NOT AVAILABLE		
DALI	1	20°	FO97261D LLI7_20WW
	2	20°	FO97262D LLI7_20WW
	1	30°	FO97261D LLI7_30WW
	2	30°	FO97262D LLI7_30WW

replace WW for
 NW 3000K
 CW 4000K

- 1 White Structure
- 2 Black Structure

tracks



surface/suspension

the original 48V track system

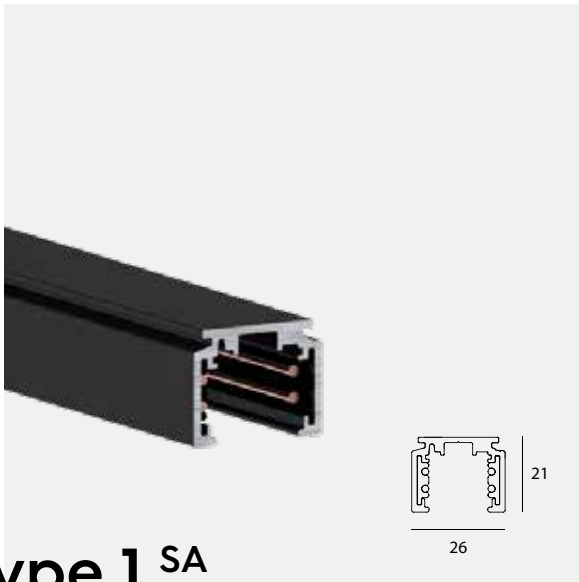

type 1 SA
48V track

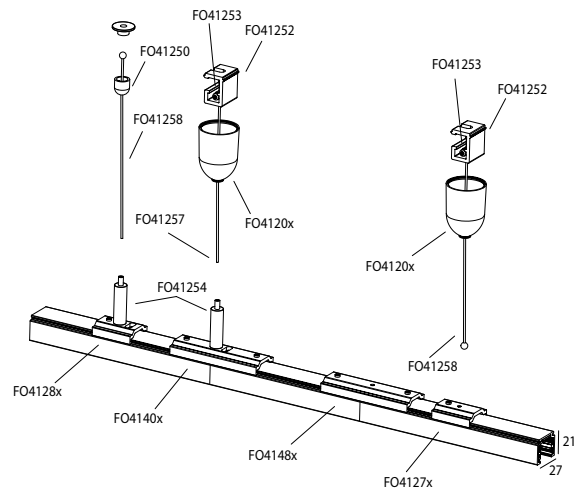

1m	2m	3m
1 FO411101E	FO411111E	FO411121E
2 FO411102E	FO411112E	FO411122E



End cap

- 1 FO411221
- 2 FO411222



End cap (cable feed)

- 1 FO411231
- 2 FO411232



Connection kit (for adjuster)

- 1 FO41401E
- 2 FO41402E



Bracket for suspension (for adjuster)

- 1 FO41281
- 2 FO41282



Bracket for suspension

- 1 FO41271
- 2 FO41272



Connection kit

- 1 FO41481E
- 2 FO41482E

surface/suspension

the original 48V track system

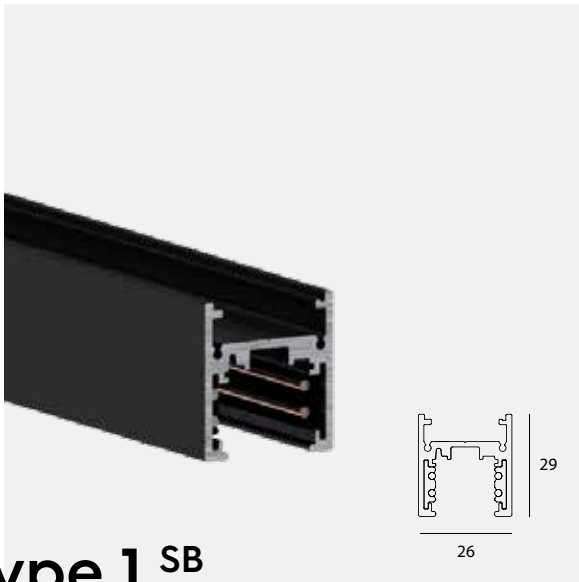

type 1 SB
48V track

1m

- 1 FO43110IE
- 2 FO431102E

2m

- FO43111IE
- FO431112E

3m

- FO43112IE
- FO431122E

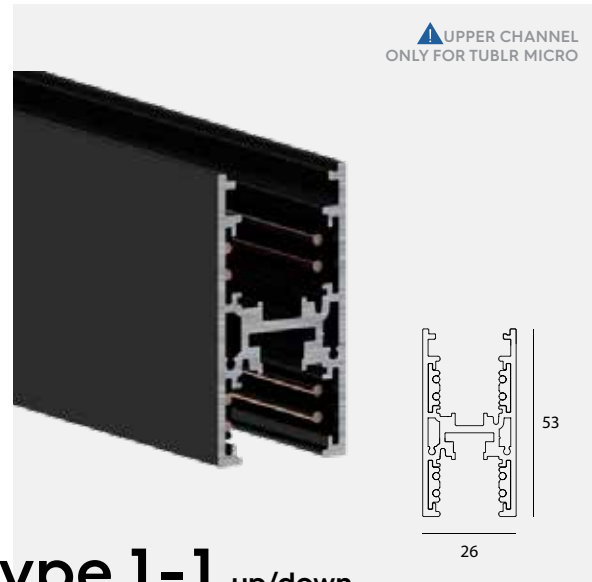

type 1-1 up/down
48V track

1m

- 1 FO43113IE
- 2 FO431132E

2m

- FO43114IE
- FO431142E

3m

- FO43115IE
- FO431152E



End cap

- 1 FO43122I
- 2 FO431222



End cap (cable feed)

- 1 FO43123I
- 2 FO431232

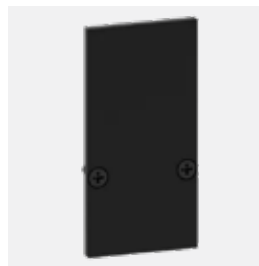

End cap

- 1 FO43124I
- 2 FO431242



Type 1 corner kit (for type 1 SB only)

- 1 FO4144IE
- 2 FO41442E

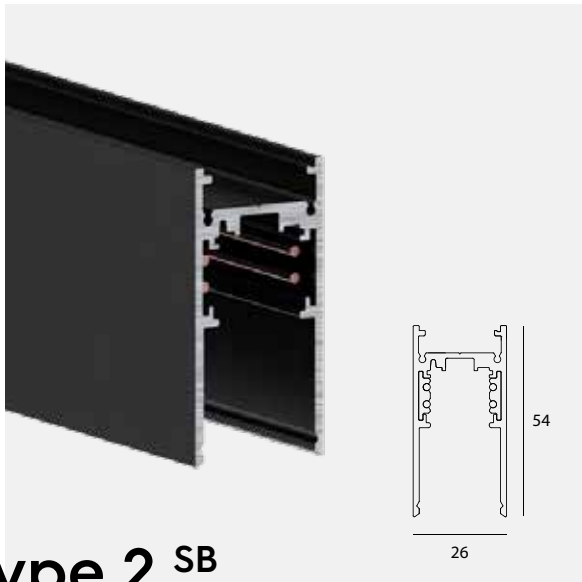

type 2^{SB}
48V track

1m	2m	3m
1 FO421101E	FO421111E	FO421121E
2 FO421102E	FO421112E	FO421122E



type 1-2 up/down
48V track

1m	2m	3m
1 FO421131E	FO421141E	FO421151E
2 FO421132E	FO421142E	FO421152E



End cap

1	FO421221
2	FO421222



End cap (cable feed)

1	FO421231
2	FO421232

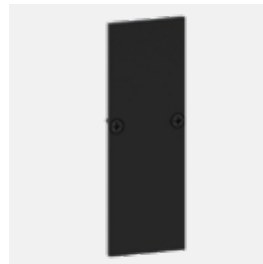

End cap

1	FO421241
2	FO421242



Type 2 corner kit (for type 2 SB only)

1	FO41451E
2	FO41452E

surface/suspension

the original 48V track system

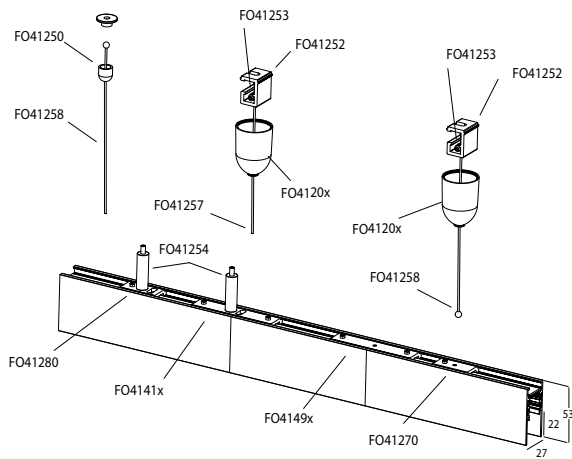

SB connection kit for suspension (for adjuster)

- 1 FO4141IE
- 2 FO41412E



SB bracket for suspension (for adjuster)

FO41280



SB connection kit for suspension

- 1 FO4149IE
- 2 FO41492E

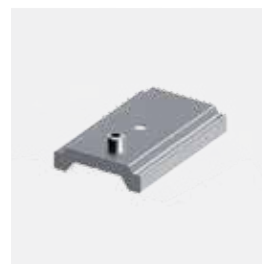

SB bracket for suspension

FO41270

recessed/trimless

the original 48V track system

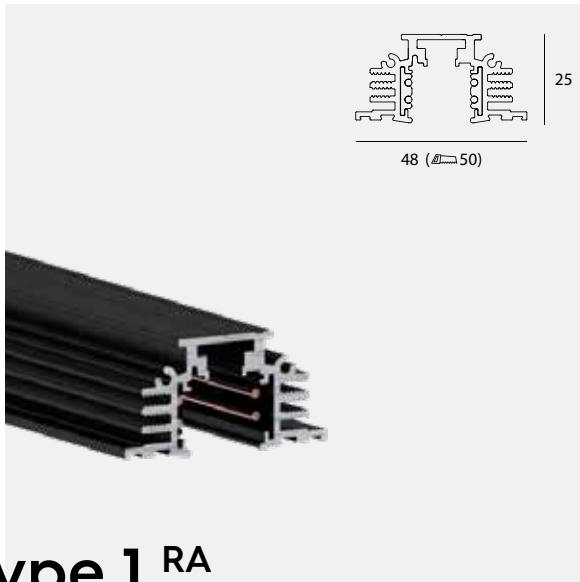

type 1 RA
48V track

	1m	2m	3m
1	FO411101RE	FO421111RE	FO4111121RE
2	FO411102RE	FO411112RE	FO411122RE

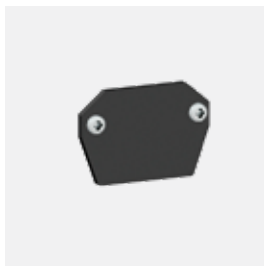

End cap

1	FO411221R
2	FO411222R

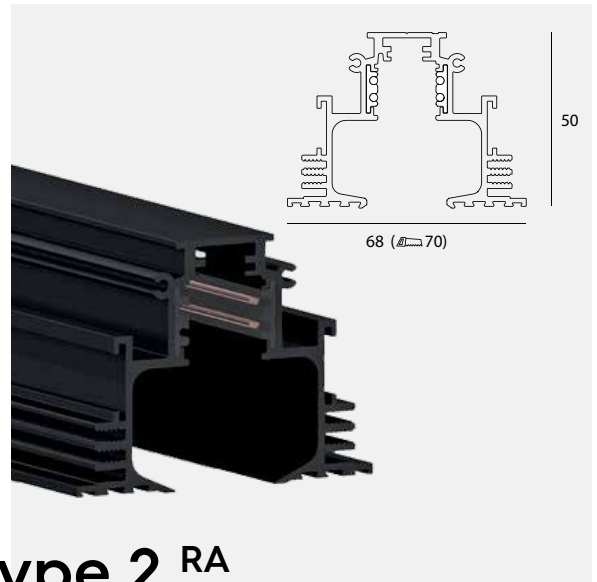

type 2 RA
48V track

	1m	2m	3m
2	FO421102R	FO421112R	FO421122R



End cap

2	FO421232R
---	-----------



RA connection kit

2	FO41472E
---	----------



RA bracket (use 4 brackets/1m track)

FO41255

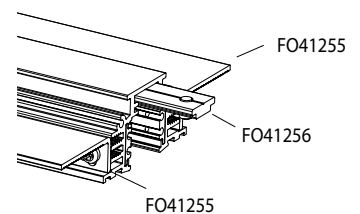

trimless recessed

the original 48V track system

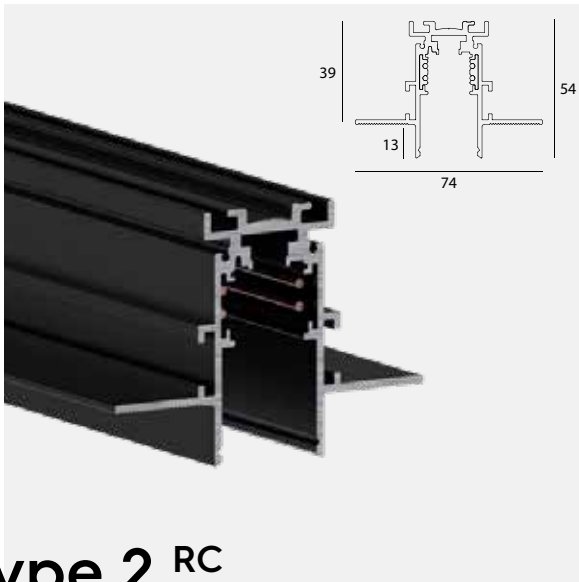

type 2 RC
48V track

1m

2 FO431102RE

2m

FO431112RE

3m

FO431122RE



type 2 RC TRIMLESS
48V track

1m

2 FO431132RE

2m

FO431142RE

3m

FO431152RE



End cap

1 FO421221

2 FO421222

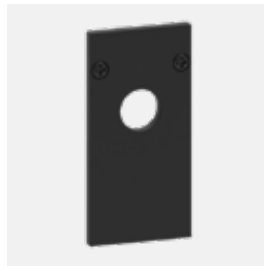

End cap (cable feed)

1 FO421231

2 FO421232



Aesthetic cover (3m)

1 FO41297

2 FO41296

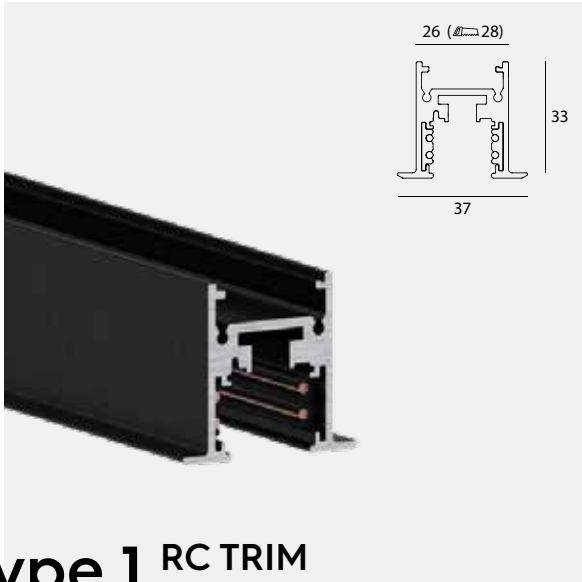

type 1 RC TRIM

48V track

1m

- 1 FO411131RE
- 2 FO411132RE

2m

- FO411141RE
- FO411142RE

3m

- FO411151RE
- FO411152RE



End cap

- 1 FO411231R
- 2 FO411232R



power & connectors

48V track system



power supply 48V

Gear box with power supply 48V non-dim 75W

- 1 FO41511
- 2 FO41512

cutting tool for track conductors required



Cutting tool
BSI200DS

connectors for custom connections & made-to-measure



End feed (left)

- 1 FO41241E
- 2 FO41242E



End feed (right)

- 1 FO41221E
- 2 FO41222E



Straight connector

- 1 FO41231E
- 2 FO41232E

all connectors
have to be
removed by
sliding them out
of the rail

not clicking in/out



Flex connector

- 1 FO41331E
- 2 FO41332E



H corner connector

- 1 FO41311E
- 2 FO41312E

suspension kits

48V track system

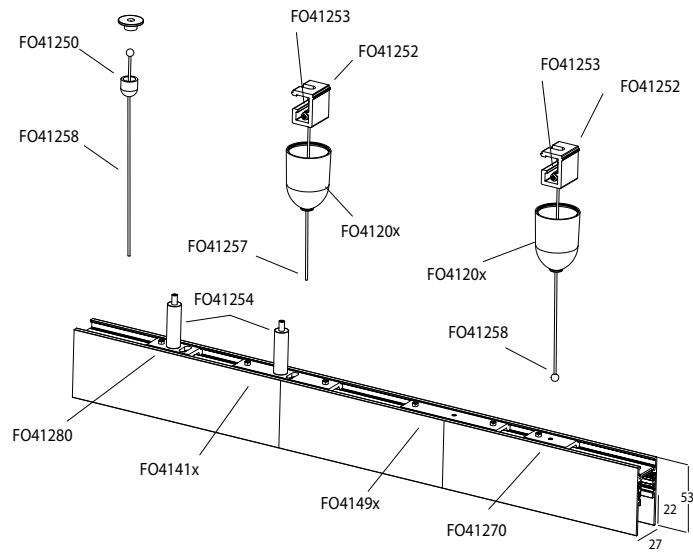

1.5m FO41257
3m FO41259



FO41252

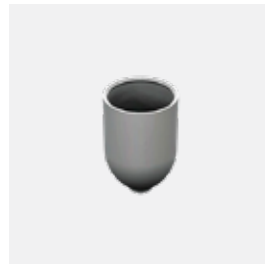

1 FO41201
2 FO41202



FO41250



1.5m FO41258
3m FO41249













FO41253

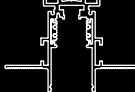
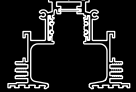

FO41254

compatibility

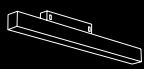
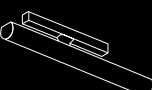
	 TYPE 1 SA SURFACE SUSPENSION	 TYPE 1 SB SURFACE SUSPENSION	 TYPE 1 RA RECESSED TRIMLESS	 TYPE 2 SB SURFACE SUSPENSION	 TYPE 2 RC RECESSED TRIMLESS	 TYPE 2 RA RECESSED TRIMLESS
 TUBLR MEDIUM TYPE 1	✓	✓	✓			
 TUBLR MEDIUM TYPE 2	✓	✓	✓	✓	✓	✓
 TUBLR MINI TYPE 1	✓	✓	✓			
 TUBLR MINI TYPE 2	✓	✓	✓	✓	✓	✓
 TUBLR MICRO TYPE 2	✓	✓	✓	✓	✓	✓
 TUBED SUSPENSION	✓	✓	✓	✓	✓	✓
 TRAXX MINI/RITHM	✓	✓	✓	✓	✓	✓
 TRAXX TWIST	✓	✓	✓	✓*	✓*	✓*

✓ COMPATIBLE

✓ COMPATIBLE - INCREASED DISTANCE BETWEEN TRACK & LUMINAIRE
* COMPATIBLE WITH TYPE 2 ON REQUEST

			
TYPE 2 RC RECESSED TRIMLESS	TYPE 1-1 SUSPENSION	TYPE 1-2 SUSPENSION	TYPE 1 RT RECESSED TRIM
	✓	✓	✓
✓	✓	✓	✓
	✓	✓	✓
		✓	✓
✓	✓	✓	✓
✓	✓	✓	✓
✓	✓	✓	✓
✓	✓	✓	✓
✓*	✓*	✓*	✓
	✓		



40

slim

compact & bright
up to 1000 lm

new
new
new

BARELY THERE TRACK SYSTEM

rounded corners
ultra-slim profile
compact spots

These ultra-slim tracks have a 50% smaller profile compared to our regular 48V rails. Pair with Tublr Micro for a tiny yet powerful system.

less than 1 cm
track height

Pair with
Tublr Micro
for a tiny,
yet powerful
system

curved tracks

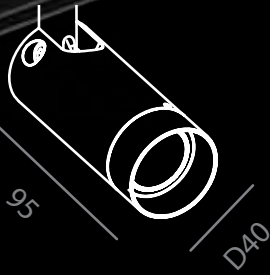

slim

48

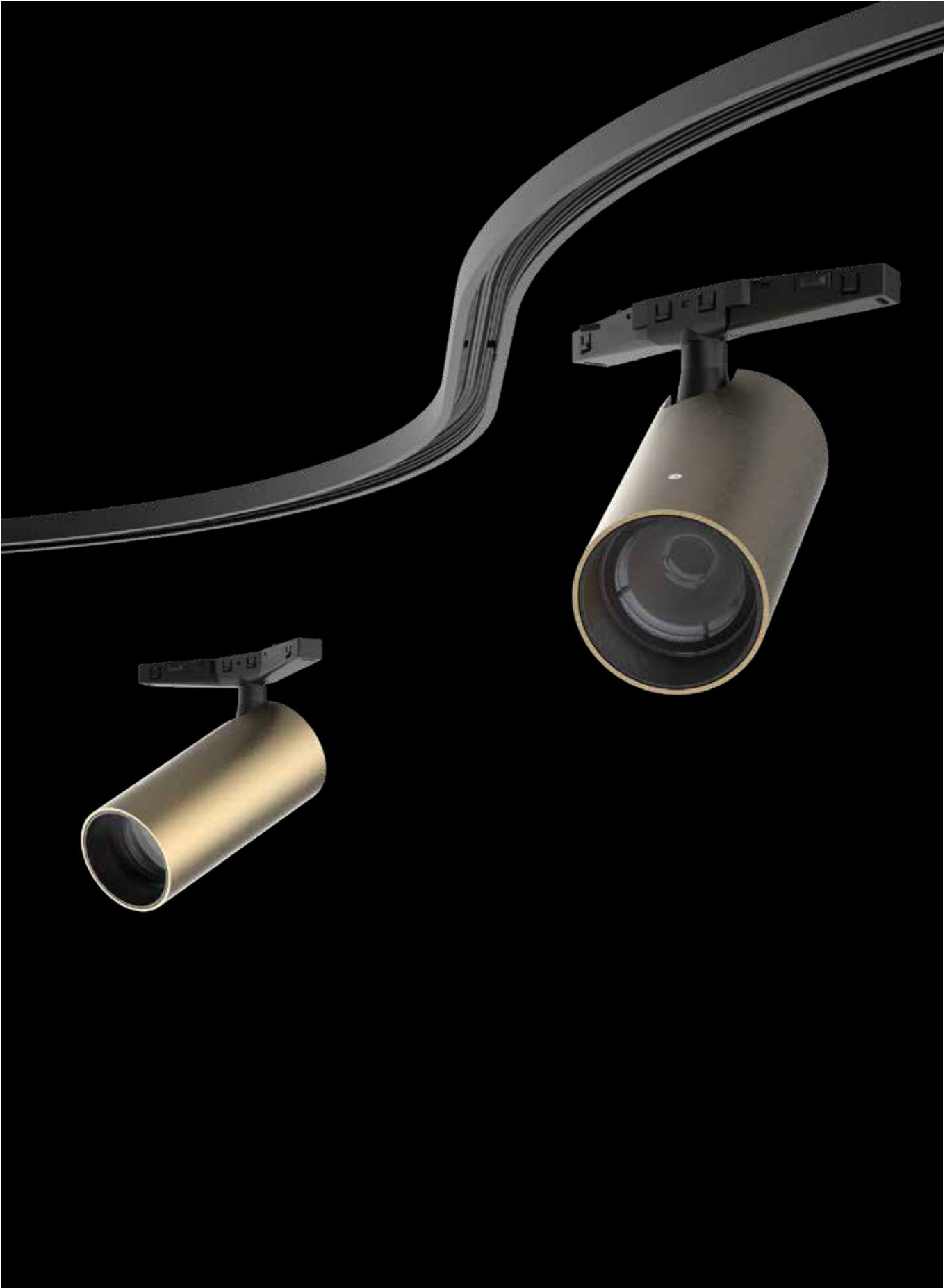



tubl'r micro slim

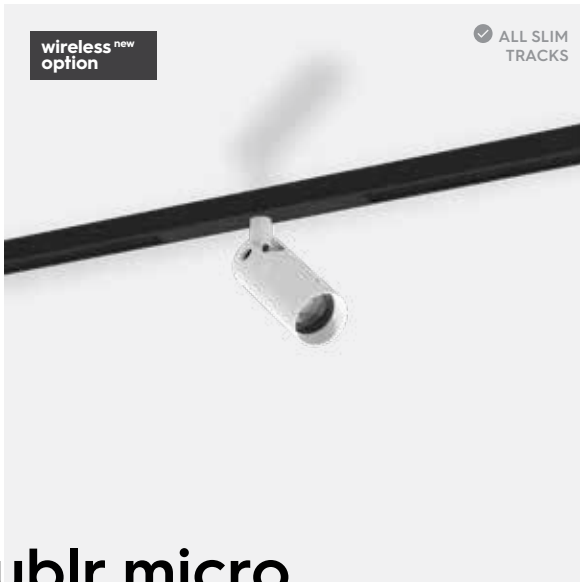

tubl'r micro 48V slim

1x COB LED 1000lm 2700K

48V 10W 1000lm 2700K CRI90+ 24°

replace CLI0_24 for
CLI0_40 40°
CLI0_60 60°

DALI

2	1
2	2

 FO98522-ID CLI0_24WW
FO98522D CLI0_24WW

HONEYCOMB D40 BS0290

replace WW for
NW 3000K
MW 3500K
CW 4000K

1x COB LED ZOOM LENS 1000lm 2700K

48V 10W 1000lm 2700K CRI90+ 20°-36°

DALI

2	1
2	2

 FO98522-ID CLI0ZLWW
FO98522D CLI0ZLWW

HONEYCOMB D40 BS0290

replace WW for
NW 3000K
MW 3500K
CW 4000K

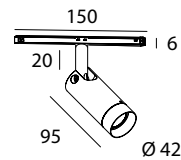

1x COB LED LENS 1000lm 2700K

48V 10W 1000lm 2700K CRI90+ 15°

replace CLI0L15 for
CLI0L24 24°
CLI0L40 40°
CLI0L50 50°

DALI

2	1
2	2

 FO98522-ID CLI0L15WW
FO98522D CLI0L15WW

HONEYCOMB D40 BS0290

replace WW for
NW 3000K
MW 3500K
CW 4000K

! Wireless dimming COMING SOON > ref= replace ...D by W
e.g. FO98522-ID becomes FO98522-IW

1

 White Structure

2

 Brushed Black

tublr micro slim

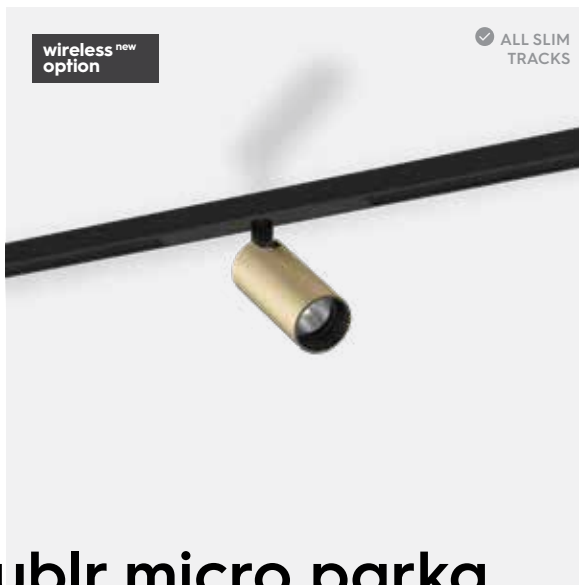

tublr micro parka 48V slim

1x COB LED 1000lm 2700K
48V 10W 1000lm 2700K CRI90+ 24°

replace CLI0_24 for
CLI0_40 40°
CLI0_60 60°

DALI	2 1 1	FO98532-1-ID CLI0_24WW
	2 1 2	FO98532-1-2D CLI0_24WW
	2 7 1	FO98532-7-ID CLI0_24WW
	2 2 2	FO98532D CLI0_24WW
	2 2 1	FO98532-2-ID CLI0_24WW
	2 7 2	FO98532-7-2D CLI0_24WW

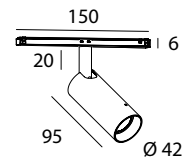

1x COB LED LENS 1000lm 2700K
48V 10W 1000lm 2700K CRI90+ 15°

replace CLI0L15 for
CLI0L24 24°
CLI0L40 40°
CLI0L50 50°

DALI	2 1 1	FO98532-1-ID CLI0L15WW
	2 1 2	FO98532-1-2D CLI0L15WW
	2 7 1	FO98532-7-ID CLI0L15WW
	2 2 2	FO98532D CLI0L15WW
	2 2 1	FO98532-2-ID CLI0L15WW
	2 7 2	FO98532-7-2D CLI0L15WW

HONEYCOMB D40

BS0290

replace WW for
NW 3000K
MW 3500K
CW 4000K

! Wireless dimming COMING SOON > ref= replace ...D by W
e.g. FO98532-1-ID becomes FO98532-1-IW

1 White Structure 7 Champagne
2 Black Structure

tubed micro

slim suspension

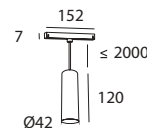

tubed micro suspension

48V slim

1x COB LED 1000lm 2700K
48V 10W 1000lm 2700K CRI90+ 24°

replace CLI0_24 for
CLI0_40 40°
CLI0_60 60°

DALI	2 1 1	FO97352-1-ID CLI0_24WW
	2 1 2	FO97352-1-2D CLI0_24WW
	2 7 1	FO97352-7-ID CLI0_24WW
	2 2 2	FO97352D CLI0_24WW
	2 2 1	FO97352-2-ID CLI0_24WW
	2 7 2	FO97352-7-2D CLI0_24WW

1x COB LED LENS 1000lm 2700K
48V 10W 1000lm 2700K CRI90+ 15°

replace CLI0L15 for
CLI0L24 24°
CLI0L40 40°
CLI0L50 50°

DALI	2 1 1	FO97352-1-ID CLI0L15WW
	2 1 2	FO97352-1-2D CLI0L15WW
	2 7 1	FO97352-7-ID CLI0L15WW
	2 2 2	FO97352D CLI0L15WW
	2 2 1	FO97352-2-ID CLI0L15WW
	2 7 2	FO97352-7-2D CLI0L15WW

HONEYCOMB D40

BS0290

replace WW for
NW 3000K
MW 3500K
CW 4000K

! Wireless dimming COMING SOON > ref= replace ...D by W
e.g. FO97322-1-ID becomes FO97322-1-IW

1 White Structure
2 Black Structure

7 Champagne

tublr micro flex

slim



tublr micro flex
48V slim

on request



traxx slim

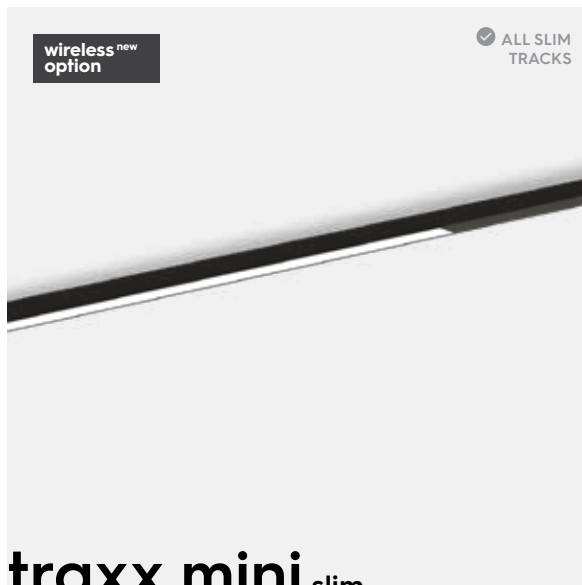

traxx mini slim 48V slim

1x LEDLINE 980lm 2700K
48V 6W 980lm 2700K CRI90+ 60°

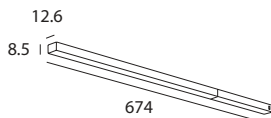

DALI

2

FO944302D LL10_60WW

1x LEDLINE 1960lm 2700K
48V 12W 1960lm 2700K CRI90+ 60°

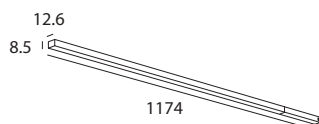

DALI

2

FO944312D LL20_60WW

1x LEDLINE 2940lm 2700K
48V 18W 2940lm 2700K CRI90+ 60°

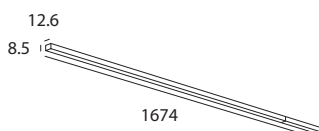

DALI

2

FO944322D LL29_60WW

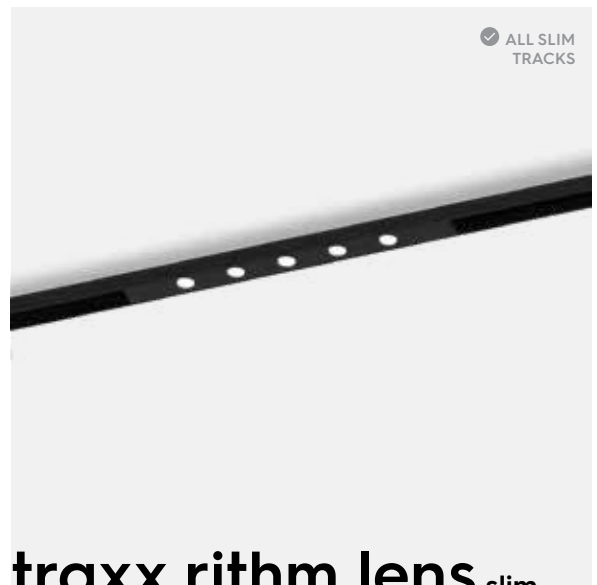

traxx rithm lens slim 48V slim

1x LEDLINE 400lm 2700K
48V 4.8W 400lm 2700K CRI90+ 20°

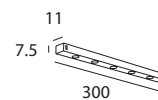

DALI

2

FO944142D LL4_20WW

replace WW for
NW 3000K

! Wireless dimming COMING SOON > ref= replace ...D by W
e.g. FO944142D becomes FO944142W

2

Black Structure

traxx rithm slim

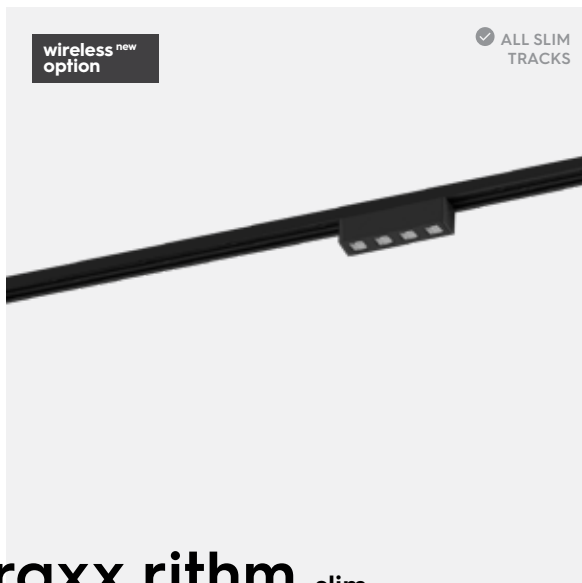

traxx rithm slim 48V slim

1x LEDLINE 690lm 2700K UGR<19
48V 7.7W 690lm 2700K CRI90+ 45°

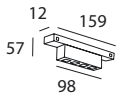

DALI 1 FO944101D LL6_45WW
2 FO944102D LL6_45WW

replace WW for
NW 3000K
CW 4000K

! Wireless dimming COMING SOON > ref= replace ...D by W
e.g. FO944102D becomes FO944102W

1x LEDLINE 1122lm 2700K UGR<19
48V 11.4W 1122lm 2700K CRI90+ 45°

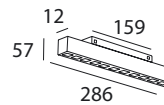

DALI 1 FO944111D LL11_45WW
2 FO944112D LL11_45WW

replace WW for
NW 3000K
CW 4000K

! Wireless dimming COMING SOON > ref= replace ...D by W
e.g. FO944102D becomes FO944102W

1x LEDLINE 450lm 2700K
48V 5.2W 450lm 2700K CRI90+

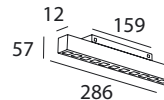

DALI 1 FO944111D LL4_20WW
2 FO944112D LL4_20WW
1 FO944111D LL4_30WW
2 FO944112D LL4_30WW

replace WW for
NW 3000K
CW 4000K

! Wireless dimming COMING SOON > ref= replace ...D by W
e.g. FO944102D becomes FO944102W

traxx rithm tilt slim

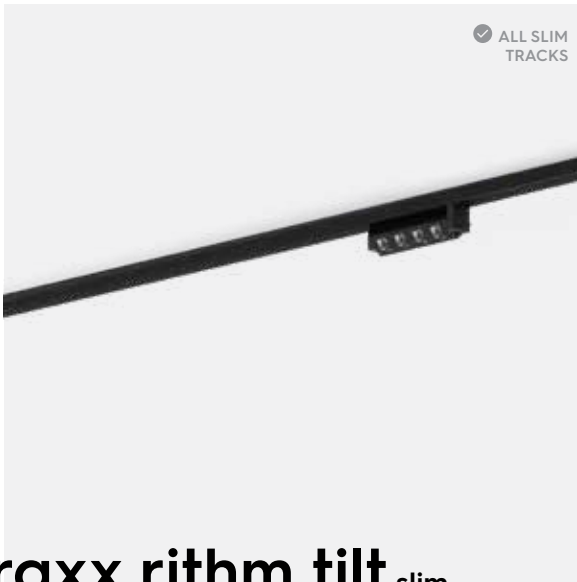

traxx rithm tilt slim 48V slim

1x LEDLINE 660lm 2700K UGR<19
48V 9.8W 660lm 2700K CRI90+ 45°

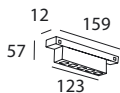

DALI	1	FO944201D LL6_45WW
	2	FO944202D LL6_45WW

replace WW for
NW 3000K

! Wireless dimming COMING SOON > ref= replace ...D by W
e.g. FO944202D becomes FO944202W

2 Black Structure

tracks

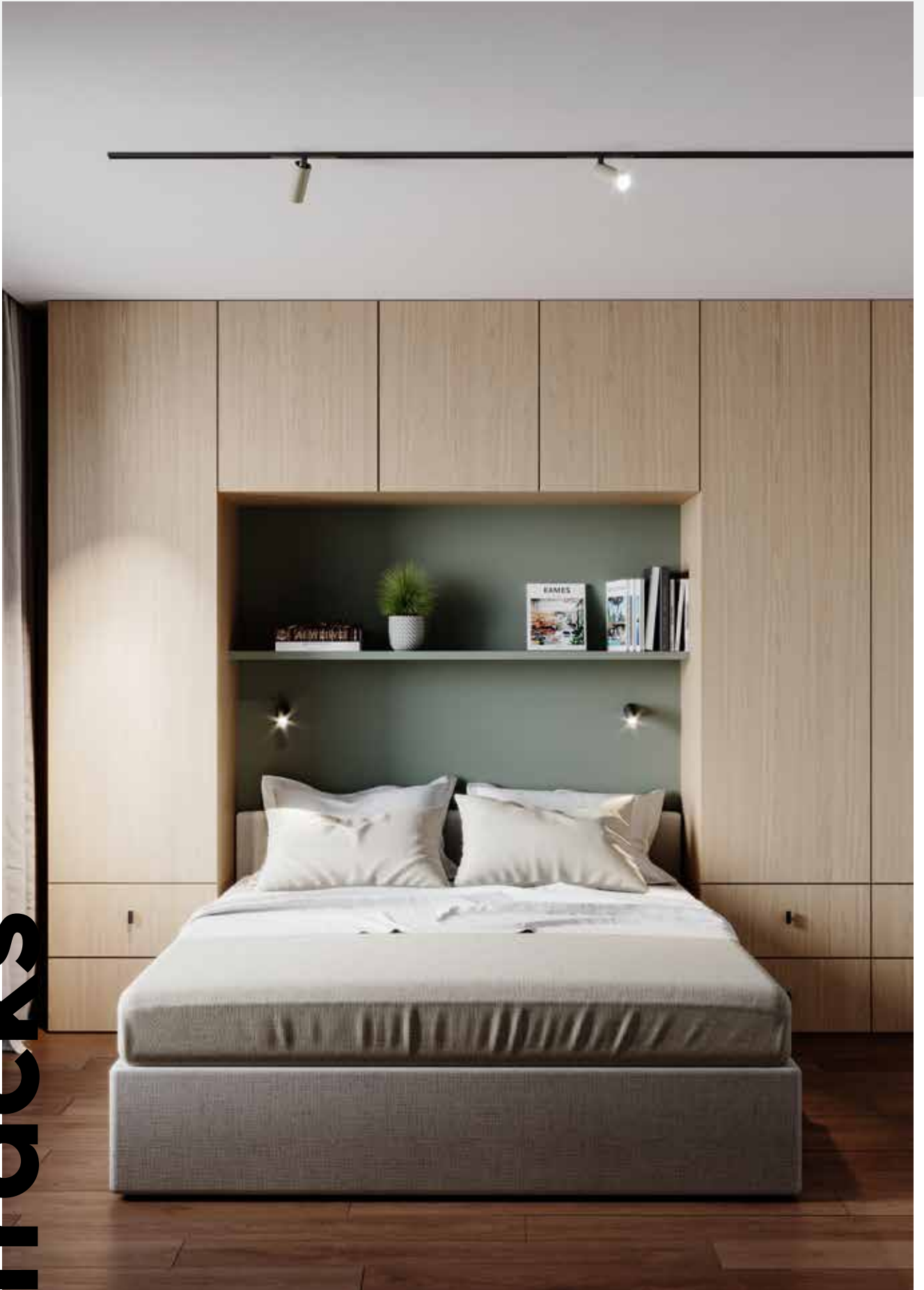

surface

48V slim track system

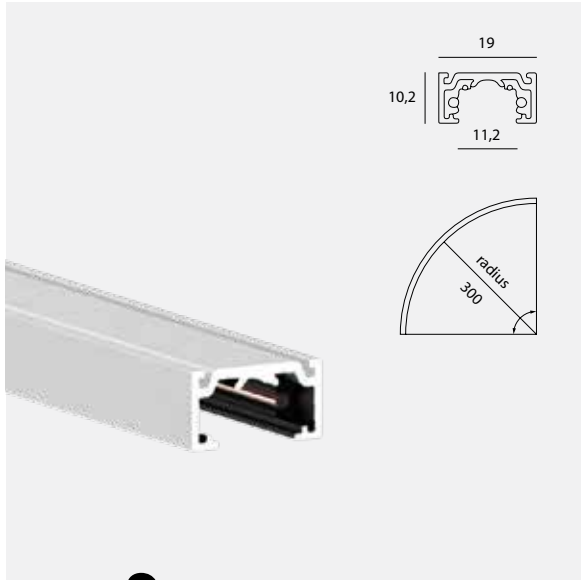

type S 48V slim

	1m	2m	3m
1	FO44101-2	FO44111-2	FO44121-2
2	FO44102	FO44112	FO44122



Curve connector kit horizontal

1	2	300mm (radius)	FO44631-2	R: 500mm	FO44651-2
2	2	R: 300mm	FO44632	R: 500mm	FO44652



Corner connector kit horizontal

1	2	FO44533
2	2	FO44532

White 48V slim type S rails
have a black finish inside and
come with black adaptors!



End cap

1	FO44131
2	FO44132

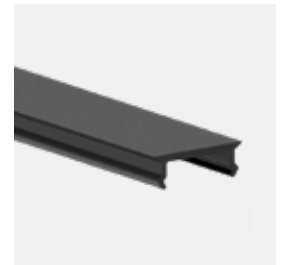

Aesthetic cover 3m

1	FO44141
2	FO44142

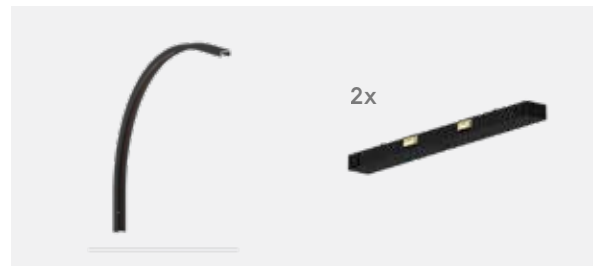

Curve connector kit vertical

1	2	R: 300mm	FO44731-2
2	2	R: 300mm	FO44732



Corner connector kit vertical

1	2	FO44531
2	2	FO44530

surface/suspension

48V slim track system



type SB
48V slim

1m

1 FO44301
2 FO44302

2m

FO44311
FO44312

3m

FO44321
FO44322

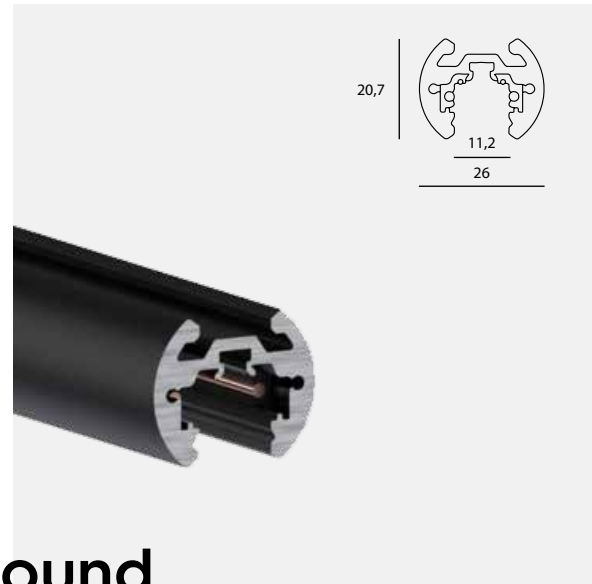

round
48V slim

1m

1 FO44401
2 FO44402

2m

FO44411
FO44412

3m

FO44421
FO44422

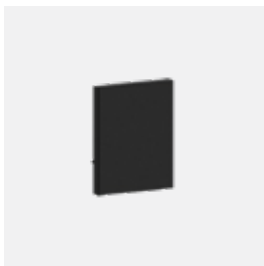

End cap

1 FO44331
2 FO44332



End cap

1 FO44431
2 FO44432



Connector kit SB + round

1 FO44381
2 FO44382

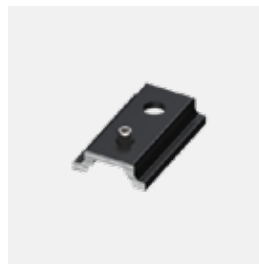

Short bracket SB + round

1 FO44371
2 FO44372

recessed

48V slim track system

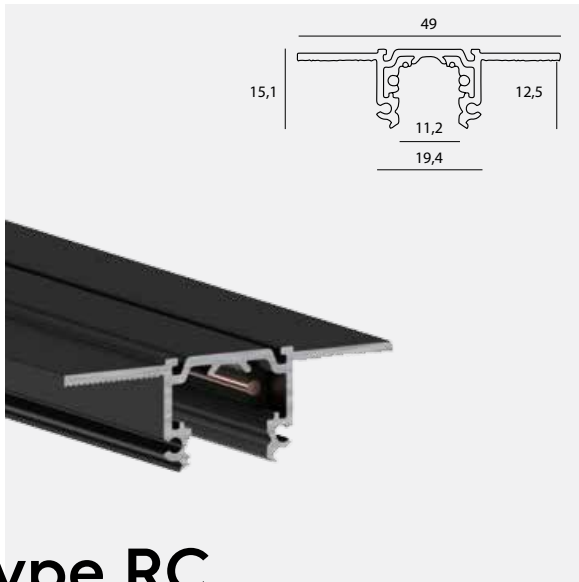

type RC 48V slim

1m	2m	3m
2 FO44202	FO44212	FO44222



End cap
2 FO44232

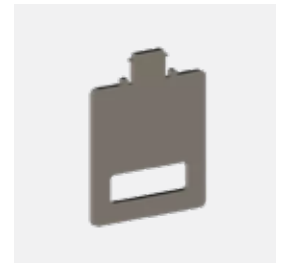

Trimless template
FO44230

covers

for type SB, round & type RC



Aesthetic cover opal 3m
FO44030

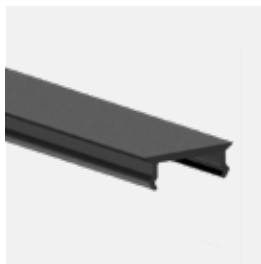

Aesthetic cover 3m
1 FO44031
2 FO44032

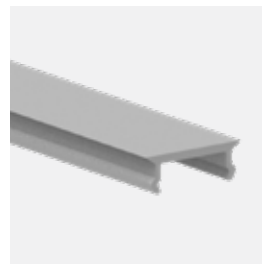

Plasterboard cover
FO44039

power & connectors

48V slim track system



power supply

48V slim

48V non-dim 75W with middle feed (cable length: 2m)

- 1 FO44611
- 2 FO44612



End feed

- 2 FO44510



Wired middle/end feed (cable length: 2m)

- 2 FO44511

all connectors
have to be
removed by
sliding them out
of the rail

not clicking in/out



Straight connector

- 2 FO44512



Flex connector

- 2 FO44515



H corner connector

- 2 FO44513



V corner connector

- 2 FO44514

cutting tool

for track conductors
required



Cutting tool

FO44000

connectors

for custom connectors
& made-to-measure

suspension kits

48V slim track system

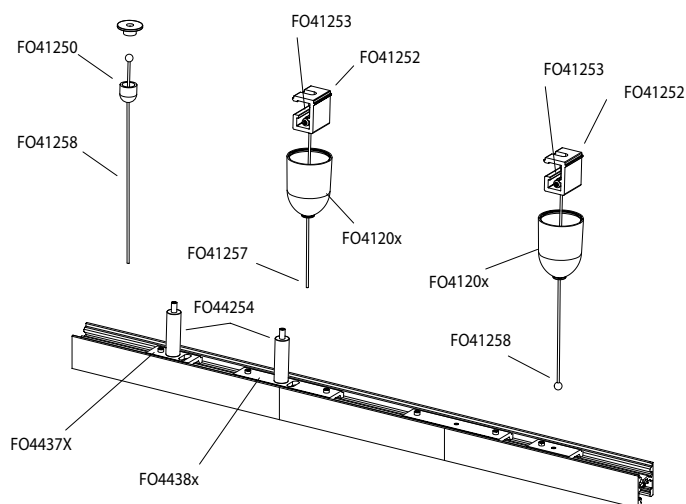

1.5m FO41257
3m FO41259



FO41252



1 FO41201
2 FO41202

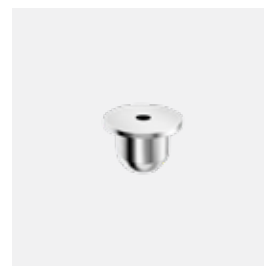

FO41250



1.5m FO41258
3m FO41249

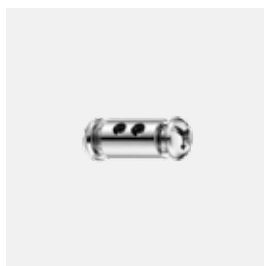









FO41253

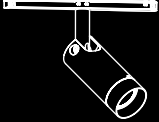

FO44254

compatibility

48V slim track system

	 S SURFACE MOUNTED	 SB SURFACE/ SUSPENSION	 ROUND SUSPENSION	 RC TRIMLESS
 TUBLR MICRO SLIM	✓	✓	✓	✓
 TRAXX SLIM LENS	✓	✓	✓	✓
 UPLIGHT LED-STRIP	✓	✓	✓	✓
 AESTHETIC COVERS	✓	✓	✓	✓

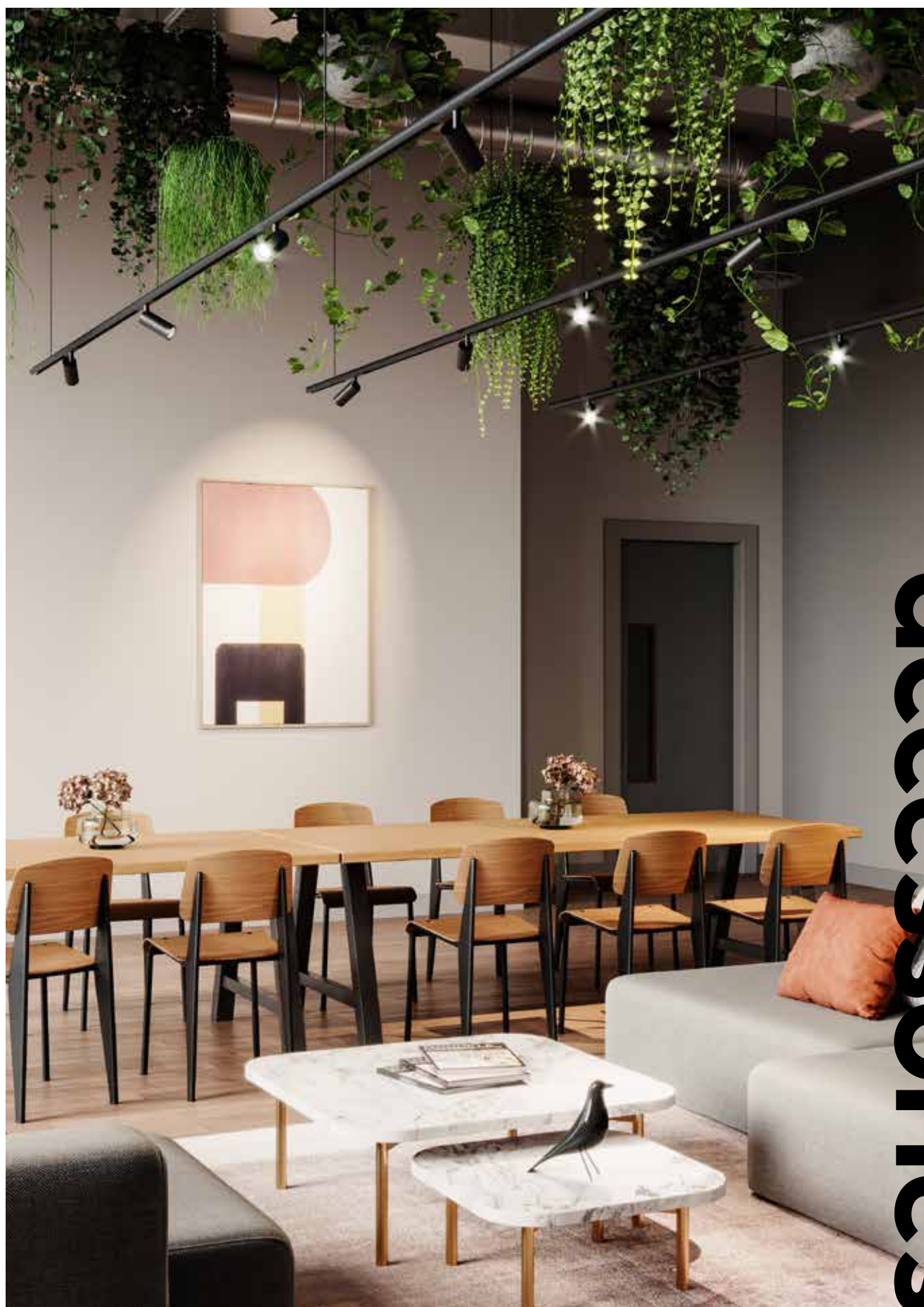

accessories

casambi ready

wireless control for DALI luminaires

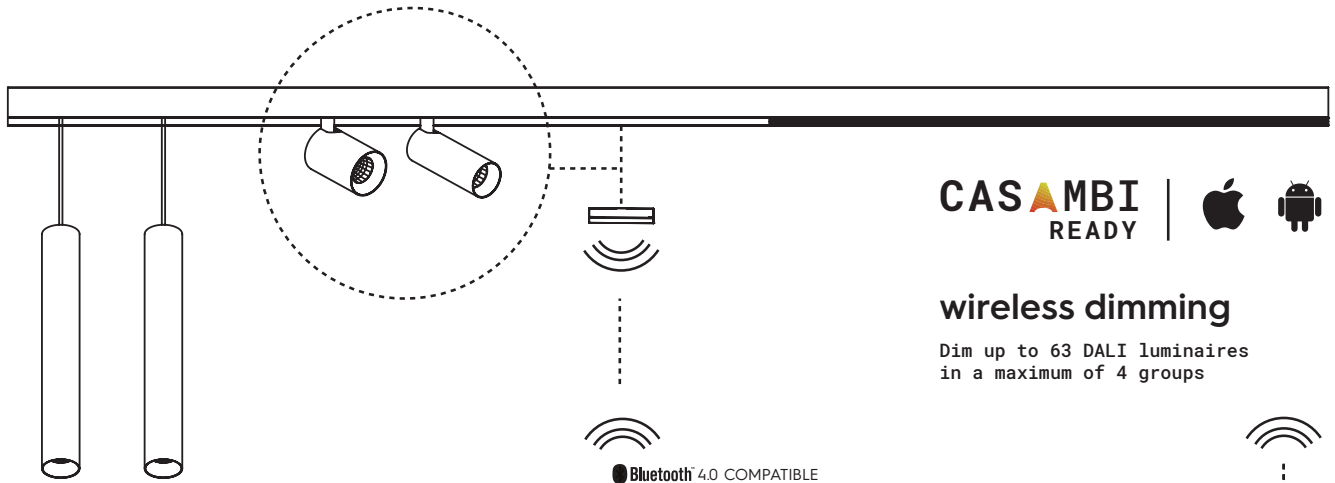

CASAMBI READY |  

wireless dimming

Dim up to 63 DALI luminaires in a maximum of 4 groups

 Bluetooth 4.0 COMPATIBLE

 Remote control
Sensor data
SW updates
Configuration



Easy Dimming

 Smart wall switches

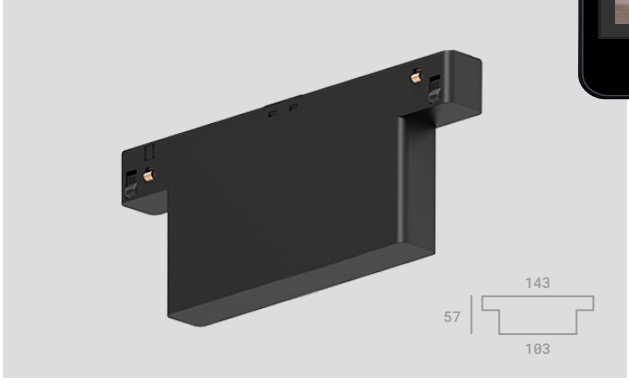

Wireless Casambi antenna

- 1 FO41191
- 2 FO41192

! Only compatible with Dali Luminaires

low voltage track

power supply

FOR T1 & T2 SB TRACK

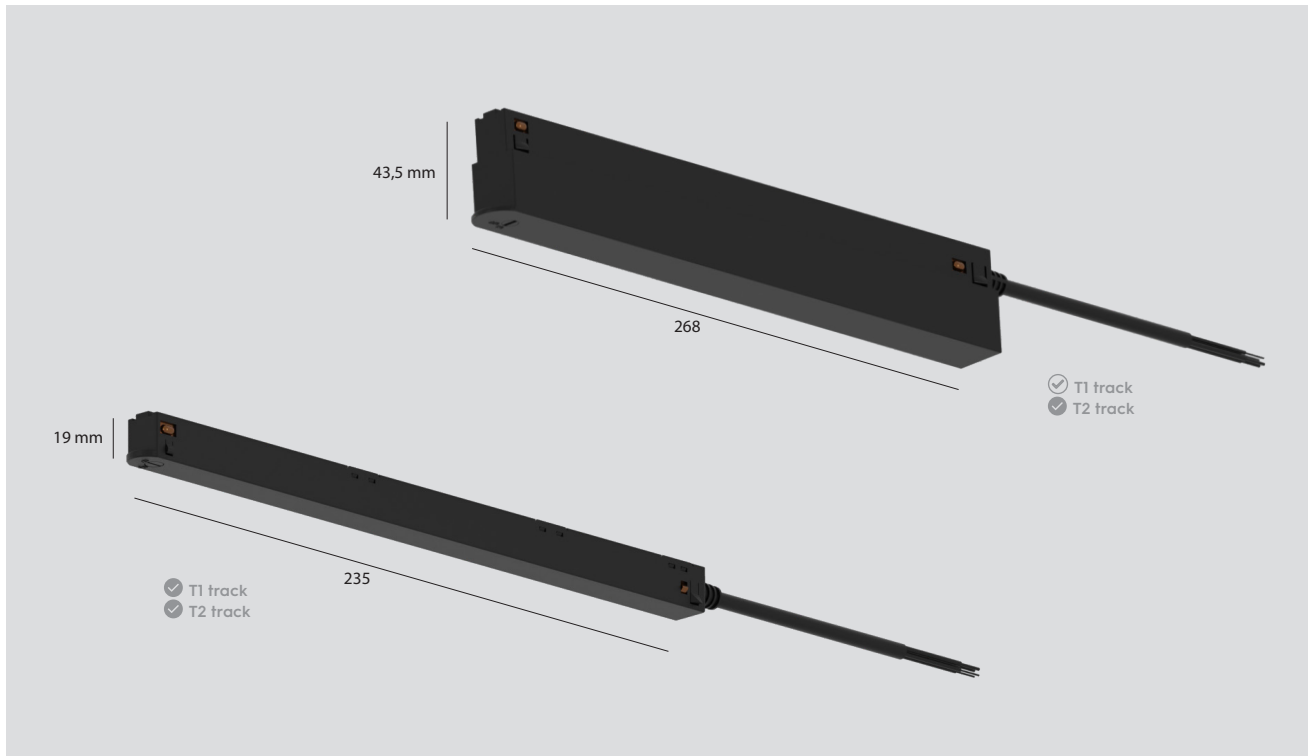

Integrated power supply 48V 100W non-dim
with DALI feed for
type 1 + 2

- 1 FO41521
- 2 FO41522

Integrated power supply 48V 250W non-dim
with DALI feed for
type 2

- 1 FO41531
- 2 FO41532

END FEED

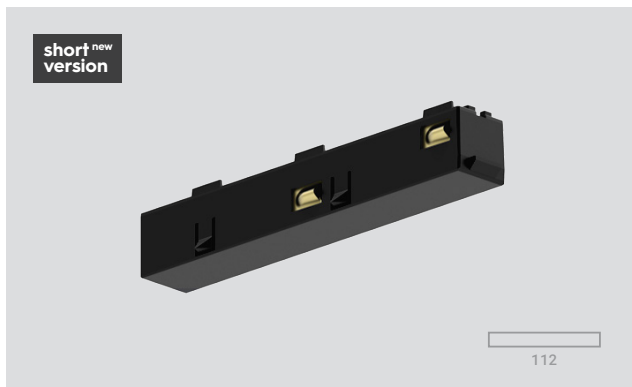

Polarized end feed

- | | | |
|---|-------------|--------------|
| | LEFT | RIGHT |
| 1 | FO41241E | FO41221E |
| 2 | FO41242E | FO41222E |



Unpolarized L feed

- 1 FO41311E
- 2 FO41312E

power supply

48V & 48V slim system

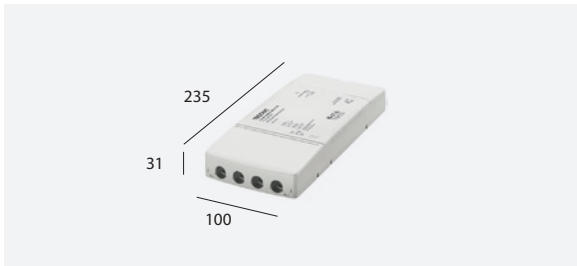

Power supply 48V non-dim

75W BS8720

150W BS8722

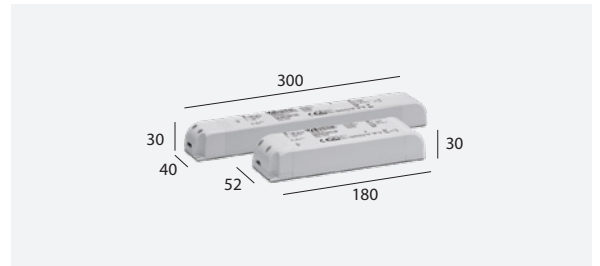

Power supply 48V non-dim

75W BS8727

120W BS8728



Power supply 48V DIN rail

240W BS8724



Power supply 48V DIN rail

480W BS8725

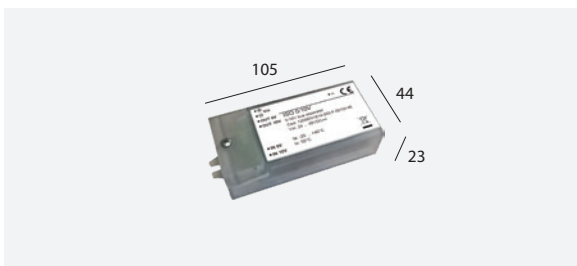

Opto-isolator 48V I-10V

2W BS8730

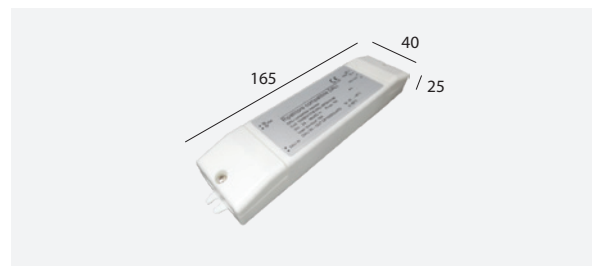

Opto-isolator 48V DALI

10W BS8729

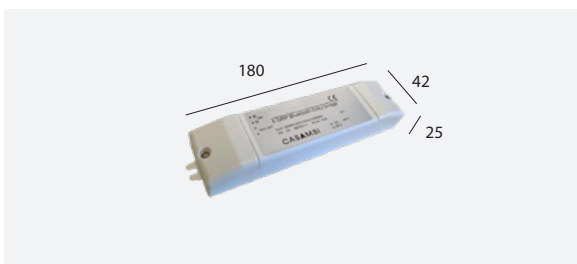

Bluetooth-DALI connector

BS9011

48V led-strips

for upper channel



48V LED STRIP

5M REEL - 14.4W/M - 205ILM/M - CRI90 - CUT-OFF: 50MM

2700K LL480002WW

3000K LL480002NW

4000K LL480002CW

Suspension clips for SB rail
(for upper channel)

FO41286

wiring diagram

48V original & slim system

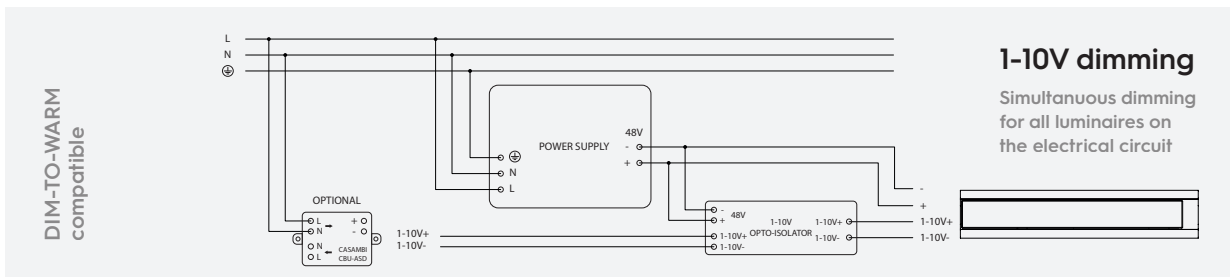
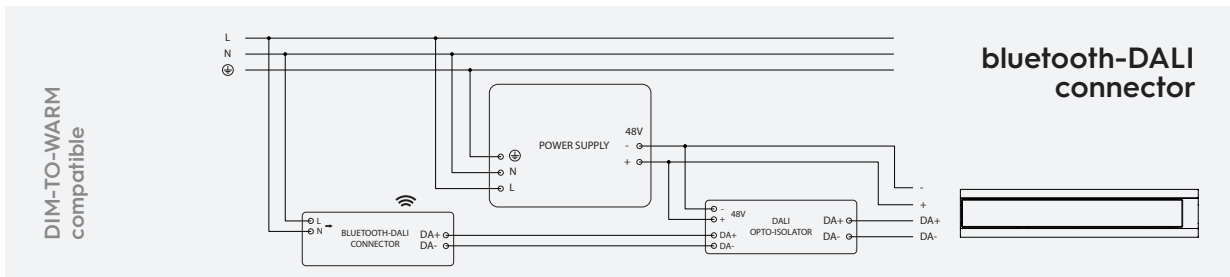
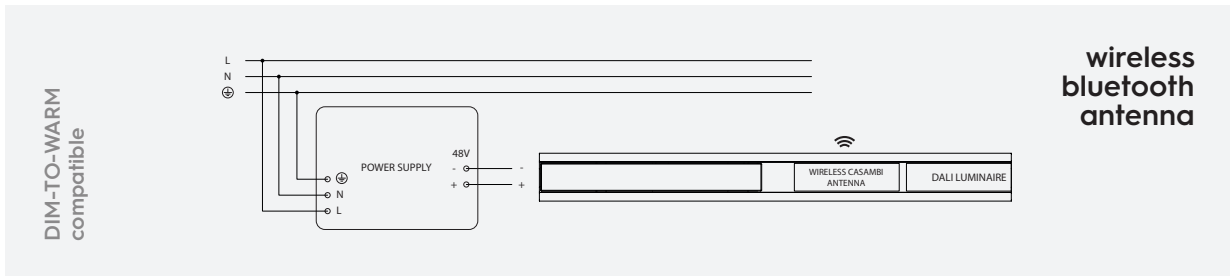
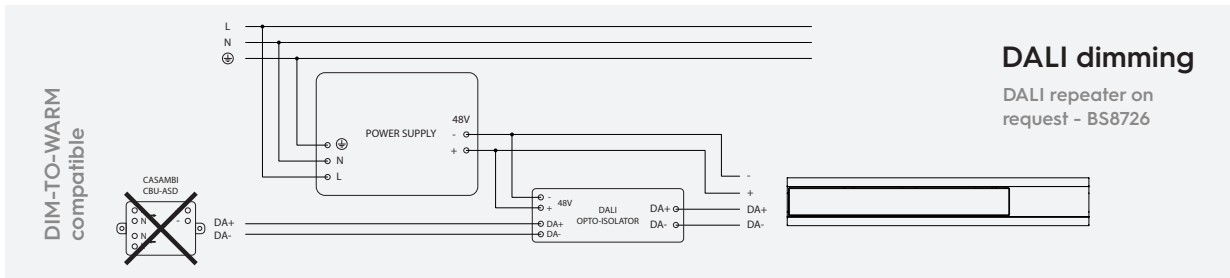
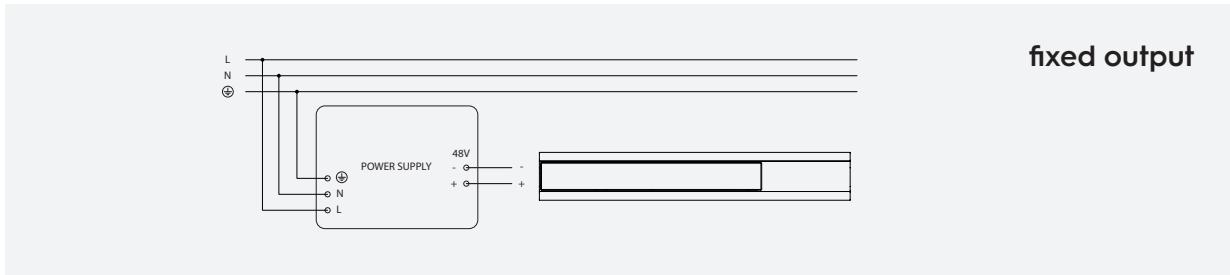

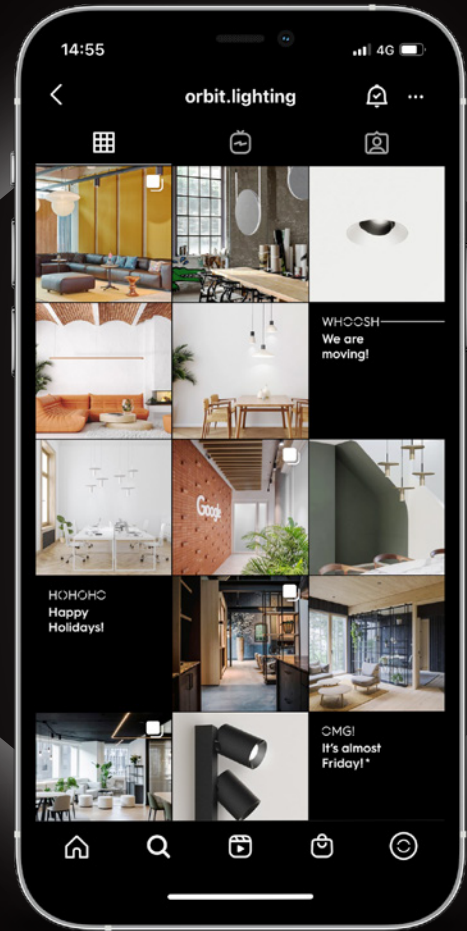

Let's connect!

We love shedding light on our projects, but we're even more curious about yours. Let's connect through the socials, shall we? We'll make your future project shine bright like a diamond.

 @ORBIT.LIGHTING

 ORBIT.ARCHITECTURAL.LIGHTING

 ORBIT-NV

 @ORBIT_LIGHTING

Want to know more?

Are you a light aficionado just like us?

Or would you like to become one?

Join one of our Orbit Academy classes. This is where we'll teach you everything about lights and luminaires and how to connect Orbit to the systems you work with. We have the technical knowledge to make lots of your luminous ideas happen. Let us share them with you. No worries about boring explanations or descriptions, as you can imagine, we like to keep it light.



**Join the Orbit
academy!**

→ learn@orbit-lighting.com

How can we help you?

Shoot! Send us an e-mail

Need a quote?	→ quote@orbit-lighting.com
Want to place an order?	→ orders@orbit-lighting.com
Have a technical question?	→ technicalsupport@orbit-lighting.com
Question about an invoice?	→ accounting@orbit-lighting.com
Do you need aftersales support?	→ aftersales@orbit-lighting.com
Partnership proposition? Let's talk!	→ marketing@orbit-lighting.com
Haven't found what you were looking for?	→ info@orbit-lighting.com

Or give us a call

+32 3 844 45 33

New products, technical data and pictures on orbit-lighting.com

hajō was designed in collaboration with renowned lighting designer Serge Cornelissen, who found inspiration in Japanese art and meditation.



Learn more
about **hajō**
and our latest
products &
projects in the
ORBIT new
brochure!



→ orbit.lighting/newbrochure

new hajō



Since over 30 years, ORBIT® develops and produces state-of-the-art architectural lighting. A good part of our fixtures are also available on Sketchup 3D Warehouse, to use in your project or visualisation.

→ 3dwarehouse.sketchup.com/by/OrbitLighting

discover all products

on orbit-lighting.com

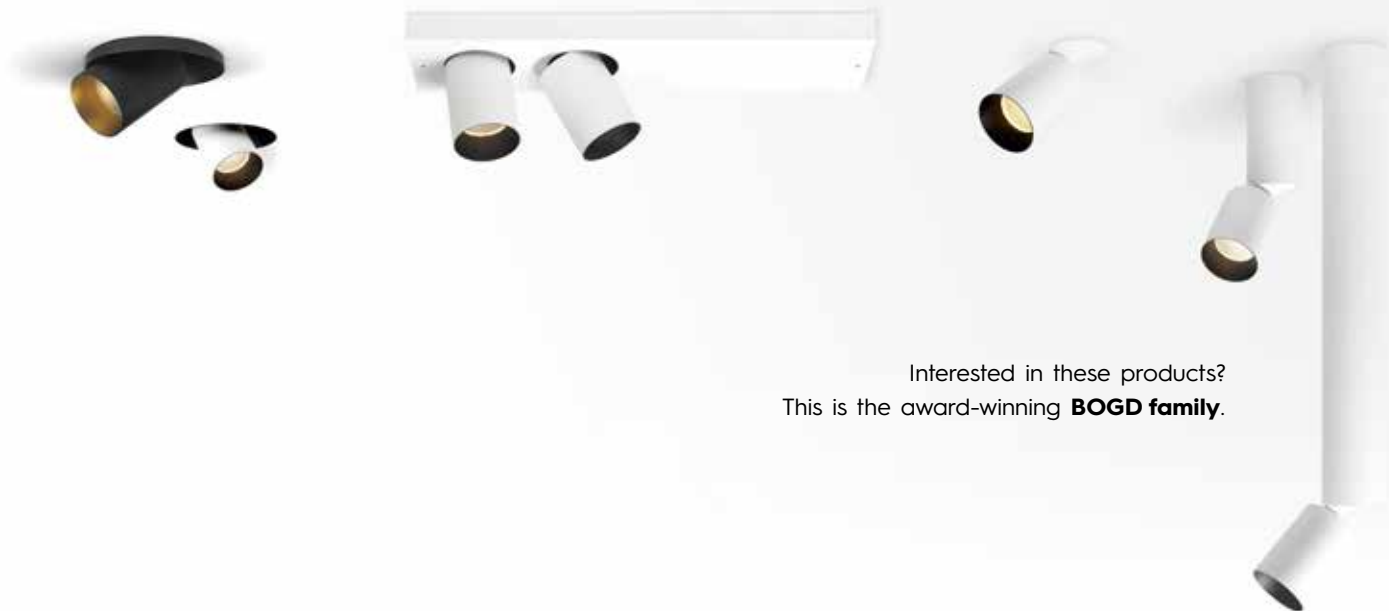

Interested in these products?
This is the award-winning **BOGD family**.

All information in this brochure replaces all preceding information.
We are not responsible for printing errors, wrong dimensions, descriptions or technical data.
The company reserves the right to amend all products herein detailed, any time and without prior notice.
Unauthorized reproductions and copies of this brochure are prohibited.

FOR FURTHER TECHNICAL INFO OR ERRATA, PLEASE VISIT WWW.ORBIT-LIGHTING.COM



ORBIT® architectural
lighting solutions

INFO@ORBIT-LIGHTING.COM /
WWW.ORBIT-LIGHTING.COM