

	CE standard / CE norm / Norme CE / CE norm		Protection level / Beschermin-datie / Indice de protection / Schutzkennziffer		Correct disposal of this product (waste electrical & electronic equipment) / Correcte verwijdering van dit product (Elektrische en elektr-onische afvalapparatuur) / Comment éliminer ce produit (Déchets d'équ-ipe-ments électriques et électroniques) / Korrekte entsorgung dieses pro-dukts (Elektromüll)
	Glow wire tested / Gloeidraadtest / Essai au fil incandescent / Glühdraht geprüft		Minimum distance lamp - object / Minimale afstand lamp - object /dis-tance minimal ampoule - objet / Min-imum Entfernung Leuchtmittel - objekt		Suitable to be mounted on normally flammable ooden surfaces / Monteerbaar op brandbare houten oppervlakte / A utiliser en surfaces normalement inflammables en bois / Montierbar auf feuergefährlichen holzoberflächen
	Fixation ceiling / Plafondbevestiging / Montage au plafond / Deckenbe-festigung		Aluminum / Aluminium / Aluminium / Aluminium		
	Fixture class 1 / Toestel klasse 1 / Appareil classe 1 / Gerät klasse 1				

<p>IMPORTANT LED INSTALLATION RESTRICTIONS</p> <ul style="list-style-type: none"> Use only power supplies that are certified according to the applicable IEC or UL safety standards. Use only SELV power supplies and check the ratings of the power supply with those of the luminaire. The maximum current rating must be taken into account. The indicated typical voltage must not be used to select a constant voltage power supply but is intended to be used to select a constant current power supply that is able to cover that typical voltage. In case the luminaire is already equipped with a power supply, the luminaire may only be used with this power supply. 	<ul style="list-style-type: none"> Take appropriate ESD measures. Avoid touching bare conductors. LED's or LED luminaires that require a current controlled power supply must never be connected in parallel. LED's can be damaged by the contact with certain chemicals or chemical gasses. Therefore led domes or led engines should never be cleaned with chemical substances. The following substances have proven to have a negative influence on the performance and must not be used in the direct environment of a led luminaire: Methyl acetate or ethyl acetate (i.e., nail polish remover), Cyanoacrylates (i.e., "Superglue"), Glycol ethers (including Radio Shack® Precision Electronics Cleaner - dipropylene glycol monomethyl ether), Formaldehyde or 	<ul style="list-style-type: none"> butadiene (including Ashland PLIOBOND® adhesive), Dymax 984-LVUF conformal coating, Loctite Sumo Glue, Gorilla Glue, Bleach, Bleach-containing cleaners and sprays, Loctite 384 adhesive, Loctite 7387 activator and Loctite 242 thread locker Remove insulation and/or provide sufficient ventilation so that the indicated max Tc is not surpassed. LED's are susceptible to switching transients. Therefore switching must be done in the primary circuit of the power supply. Orbit recommends to use the power supplies that are indicated in the Orbit Catalogue. Respect polarity in order not to damage the LED's. Don't test LED luminaires one by one on a power supply that is switched on.
---	---	---

NED

- Het verlichtingsartikel moet worden geïnstalleerd door een erkend vakman.
- Schakel altijd eerst de elektriciteit uit voor installatie, onderhoud of herstelling
- Vervang een gebarsten of gebroken beschermglas onmiddellijk en gebruik uitsluitend originele wisselstukken.
- Gebruik hittebestendige kabel om de armatuur aan te sluiten op het net.
- De armatuur is enkel geschikt voor vaste bevestiging en mag daarom niet worden aangesloten aan de stroombron door middel van een aansluitnoer.
- Gebruik uitsluitend lampen van het juiste type en overschrijd nooit het maximum aangegeven wattage.
- Draai steeds de klemmschroeven van alle elektrische aansluitingen stevig aan, vooral bij 12V laagspanningsdraden.
- Houd bij de aansluiting van de bedrading de juiste kleuren in acht: blauw (N), bruin of zwart (L) en bij beschermklasse I, geelgroen (aardleiding). Let er bij installatie ook op dat er geen elektrische leidingen in de muur of in het plafond worden doorboord. Onderhoud binnenverlichting met een droge doek of een borsteltje, gebruik geen schuur- of oplosmiddelen. Vermijd vocht op alle elektrische onderdelen.
- Respecteer altijd alle technische specificaties & veiligheidsinstructies ivm uw armatuur, zie gebruiksaanwijzing.

DEU

- Halten Sie die lokalen Installationsvorschriften ein. Die Installation vorschreiben geben an, dass ein Beleuchtungsartikel von einem zugelassenen Fachmann installiert werden muss.
- Schalten Sie vor der Installation, Wartung oder Reparatur immer zuerst die Elektrizität aus.
- Ersetzen Sie ein geborstenes oder gebrochenes Schutzglas unmittelbar und verwenden Sie ausschließlich originale Ersatzteile.
- Verwenden Sie ein hitzebeständiges Kabel, um die Leuchte am Stromnetz anzuschließen.
- Die Leuchte eignet sich nur für eine feste Befestigung und darf deshalb nicht mit Hilfe eines Anschlusskabels an der Stro- quelle angeschlossen werden.
- Verwenden Sie ausschließlich Lampen des richtigen Typs und überschreiten Sie niemals den Höchs wert
- der angegebenen Wattzahl. Ziehen Sie immer die Klemmschrauben aller ele trischen Anschlüsse fest an, vor allem bei 12V-Niederspannungsdrähten.
- Achten Sie beim Anschluss der Verdrahtung auf die richtigen Farben: blau (N), braun oder schwarz (L) und bei Schutzklasse I, gelbgrün (Erdeleitung).
- Achten Sie bei der Installation auch darauf, dass keine elektrischen Leitungen in der Wand oder an der Decke durchbohrt werden.Reinigen Sie die Innenbeleuchtung mit einem trockenen Tuch oder einer Bürste, verwenden Sie keine Scheuer- oder Lösungsmittel. Vermeiden Sie Feuchtigkeit auf allen elektrischen Bestandteilen.
- Beachten Sie immer alle technischen Spezifikationen & Siche heitsinstruktionen in Zusammenhang mit Ihrer Leuchte, siehe Gebrauchsanweisung.

ENG

- The light fittings must be installed by a qualified electrician.
- Always switch off the power before any installation, maintenance or repair work
- Replace cracked or broken protective glass covers immediately and only use original replacement parts.
- Use a heat resistant cable to connect the light fitting to the mains.
- The fitting is only suitable to be installed as a fixture. Therefore, do not connect it to the power supply with a power lead.
- Only use the correct type of light bulb and never exceed the maximum stated wattage.
- Always ensure that the fixing screws of all electrical connections are screwed in tightly, especially in the case of 12 V low voltage wires.
- Ensure that you use the correct colours when connecting the wires, for example, blue (N), brown or black (L) and in the case of category I protection, yellow/green (earth).When installing the fitting, ensure that you do not drill through any electrical wiring in the wall or in the ceiling.
- Interior light fittings should be cleaned with a dry cloth or a small brush. Do not use any abrasives or solvents. Ensure that electrical parts do not come into contact with any moisture.
- Always comply with all the technical specifications and safety instructions relating to your fitting, see instructions for use.

FRA

- Respectez dans tous les cas les consignes d'installation locales. Toutes consignes d'installation prévoient en effet l'installation des armatures d'éclairage par un spécialiste agréé.
- Toujours éteindre l'électricité pour l'installation, l'entretien ou le dépannage.
- Remplacez immédiatement un verre de protection fendu ou cassé et n'utilisez que des pièces d'origine.
- Utilisez des câbles résistants à la chaleur pour connecter l'armature au réseau.
- L'armature convient exclusivement pour une installation fixe et ne peut dès lors être connectée à la source de courant au moyen d'une rallonge électrique.
- N'utilisez que des lampes du type adéquat et n'exécédez jamais la puissance maximum indiquée (nombre de watts).
- Serrez toujours fermement les vis de serrage de toute connexion électrique, surtout pour les câbles basse tension de 12V.
- Respectez la couleur des câbles lors du raccordement: bleu (N), brun ou noir (L) et, pour la classe de protection I, vert - jaune (prise de terre).Lors de l'installation, veillez à ne pas perforer de gaines électriques situées dans le mur ou le plafond.
- Pour l'entretien des éclairages d'intérieur, utilisez un chiffon sec ou une brosse. N'utilisez jamais de produits abrasifs ou de solvants. Évitez toute humidité sur les éléments électriques.
- Respectez toujours toutes les spécifications techniques & consignes de sécurité concernant votre armature, voir mode d'emploi.



BORDERLESS MEDIUM TRIM
CEILING / RECESSED

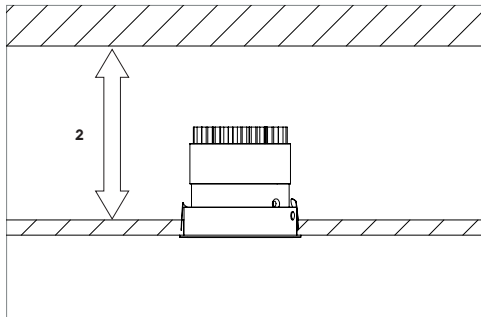

FOR MORE PRODUCT SPECIFICATIONS, PLEASE SEE WEBSITE



CEILING REQUIREMENTS

-  1. 75 mm
-  2. 1000 lm > 85 mm
2000 lm > 115 mm

LAMP WALL DISTANCE



1

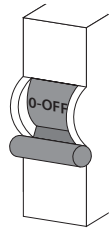

2

Ø 75 mm

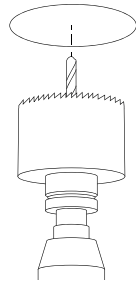

5

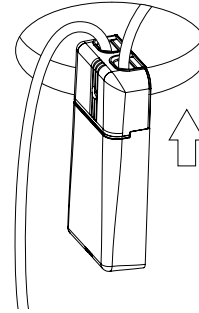

6

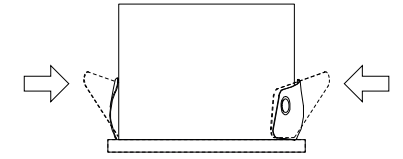

3

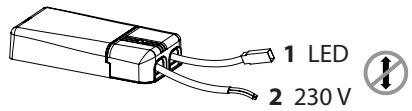

4

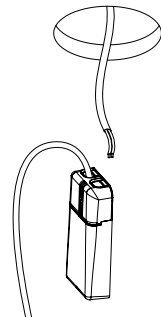

7

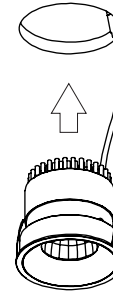

8

